

eReplacementParts.com

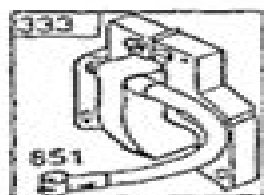
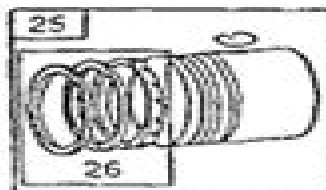
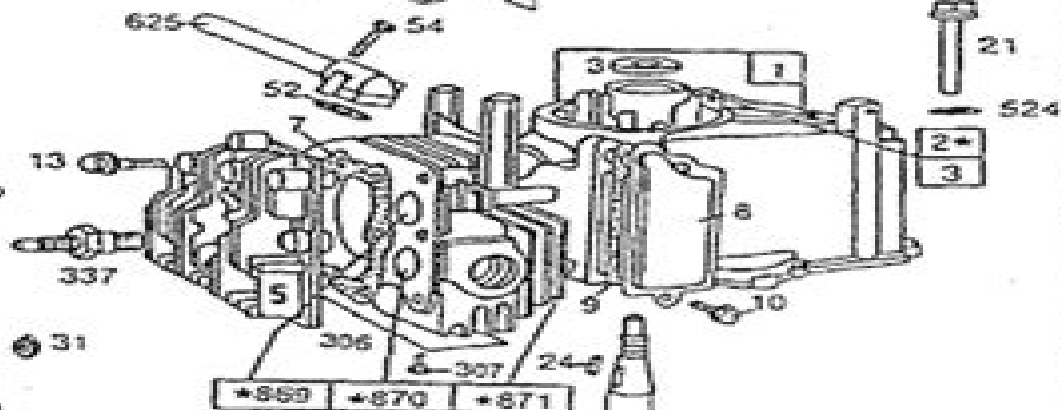
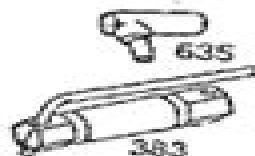
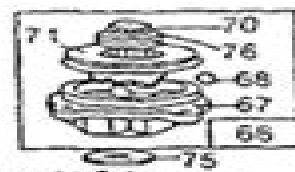
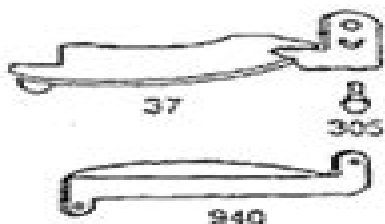
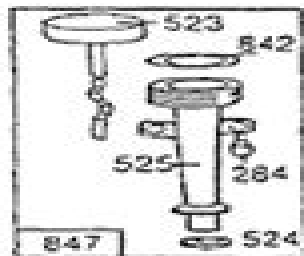

1019 LABEL KIT

358 GASKET SET

*REQUIRES SPECIAL TOOLS TO INSTALL.
SEE REPAIR INSTRUCTION MANUAL.

Manual For Briggs And Stratton 11hp

J Spring



Manual For Briggs And Stratton 11hp:

Popular Science ,1980-04 Popular Science gives our readers the information and tools to improve their technology and their world The core belief that Popular Science and our readers share The future is going to be better and science and technology are the driving forces that will help make it better

Field & Stream ,1981-03 FIELD STREAM America s largest outdoor sports magazine celebrates the outdoor experience with great stories compelling photography and sound advice while honoring the traditions hunters and fishermen have passed down for generations

Popular Science ,1981-07 Popular Science gives our readers the information and tools to improve their technology and their world The core belief that Popular Science and our readers share The future is going to be better and science and technology are the driving forces that will help make it better

Popular Science ,1980-08 Popular Science gives our readers the information and tools to improve their technology and their world The core belief that Popular Science and our readers share The future is going to be better and science and technology are the driving forces that will help make it better

Popular Mechanics ,1979-04 Popular Mechanics inspires instructs and influences readers to help them master the modern world Whether it s practical DIY home improvement tips gadgets and digital technology information on the newest cars or the latest breakthroughs in science PM is the ultimate guide to our high tech lifestyle

Official Guide, Tractors and Farm Equipment ,1981

Popular Mechanics ,1981-08 Popular Mechanics inspires instructs and influences readers to help them master the modern world Whether it s practical DIY home improvement tips gadgets and digital technology information on the newest cars or the latest breakthroughs in science PM is the ultimate guide to our high tech lifestyle

Small AC Generator Service Manual ,1986

Field & Stream ,1981-02 FIELD STREAM America s largest outdoor sports magazine celebrates the outdoor experience with great stories compelling photography and sound advice while honoring the traditions hunters and fishermen have passed down for generations

Popular Science ,1980-02 Popular Science gives our readers the information and tools to improve their technology and their world The core belief that Popular Science and our readers share The future is going to be better and science and technology are the driving forces that will help make it better

Metal Construction ,1975

Popular Mechanics ,1981-05 Popular Mechanics inspires instructs and influences readers to help them master the modern world Whether it s practical DIY home improvement tips gadgets and digital technology information on the newest cars or the latest breakthroughs in science PM is the ultimate guide to our high tech lifestyle

Field & Stream ,1980-02 FIELD STREAM America s largest outdoor sports magazine celebrates the outdoor experience with great stories compelling photography and sound advice while honoring the traditions hunters and fishermen have passed down for generations

Popular Science ,1981-10 Popular Science gives our readers the information and tools to improve their technology and their world The core belief that Popular Science and our readers share The future is going to be better and science and technology are the driving forces that will help make it better

Field & Stream ,1981-12 FIELD STREAM

America's largest outdoor sports magazine celebrates the outdoor experience with great stories, compelling photography and sound advice while honoring the traditions hunters and fishermen have passed down for generations. **Popular Science**, 1982-09 Popular Science gives our readers the information and tools to improve their technology and their world. The core belief that Popular Science and our readers share: The future is going to be better and science and technology are the driving forces that will help make it better. **Popular Mechanics**, 1983-07 Popular Mechanics inspires, instructs and influences readers to help them master the modern world. Whether it's practical DIY home improvement tips, gadgets and digital technology information on the newest cars or the latest breakthroughs in science, PM is the ultimate guide to our high tech lifestyle. *Popular Science*, 1983-05 Popular Science gives our readers the information and tools to improve their technology and their world. The core belief that Popular Science and our readers share: The future is going to be better and science and technology are the driving forces that will help make it better. *Popular Mechanics*, 1980-11 Popular Mechanics inspires, instructs and influences readers to help them master the modern world. Whether it's practical DIY home improvement tips, gadgets and digital technology information on the newest cars or the latest breakthroughs in science, PM is the ultimate guide to our high tech lifestyle. *Popular Mechanics*, 1981-02 Popular Mechanics inspires, instructs and influences readers to help them master the modern world. Whether it's practical DIY home improvement tips, gadgets and digital technology information on the newest cars or the latest breakthroughs in science, PM is the ultimate guide to our high tech lifestyle.

Unveiling the Energy of Verbal Artistry: An Mental Sojourn through **Manual For Briggs And Stratton 11hp**

In a world inundated with screens and the cacophony of fast conversation, the profound power and psychological resonance of verbal beauty often diminish in to obscurity, eclipsed by the continuous onslaught of sound and distractions. Yet, situated within the musical pages of **Manual For Briggs And Stratton 11hp**, a interesting work of literary beauty that pulses with organic emotions, lies an unforgettable trip waiting to be embarked upon. Penned by way of a virtuoso wordsmith, that magical opus guides readers on a mental odyssey, gently revealing the latent potential and profound affect embedded within the elaborate internet of language. Within the heart-wrenching expanse of the evocative analysis, we will embark upon an introspective exploration of the book is main styles, dissect their interesting publishing style, and immerse ourselves in the indelible effect it leaves upon the depths of readers souls.

https://staging.conocer.cide.edu/files/virtual-library/Documents/mcgraw_hill_answer_key_science_grade_5.pdf

Table of Contents Manual For Briggs And Stratton 11hp

1. Understanding the eBook Manual For Briggs And Stratton 11hp
 - The Rise of Digital Reading Manual For Briggs And Stratton 11hp
 - Advantages of eBooks Over Traditional Books
2. Identifying Manual For Briggs And Stratton 11hp
 - Exploring Different Genres
 - Considering Fiction vs. Non-Fiction
 - Determining Your Reading Goals
3. Choosing the Right eBook Platform
 - Popular eBook Platforms
 - Features to Look for in an Manual For Briggs And Stratton 11hp
 - User-Friendly Interface
4. Exploring eBook Recommendations from Manual For Briggs And Stratton 11hp
 - Personalized Recommendations

- Manual For Briggs And Stratton 11hp User Reviews and Ratings
- Manual For Briggs And Stratton 11hp and Bestseller Lists
- 5. Accessing Manual For Briggs And Stratton 11hp Free and Paid eBooks
 - Manual For Briggs And Stratton 11hp Public Domain eBooks
 - Manual For Briggs And Stratton 11hp eBook Subscription Services
 - Manual For Briggs And Stratton 11hp Budget-Friendly Options
- 6. Navigating Manual For Briggs And Stratton 11hp eBook Formats
 - ePub, PDF, MOBI, and More
 - Manual For Briggs And Stratton 11hp Compatibility with Devices
 - Manual For Briggs And Stratton 11hp Enhanced eBook Features
- 7. Enhancing Your Reading Experience
 - Adjustable Fonts and Text Sizes of Manual For Briggs And Stratton 11hp
 - Highlighting and Note-Taking Manual For Briggs And Stratton 11hp
 - Interactive Elements Manual For Briggs And Stratton 11hp
- 8. Staying Engaged with Manual For Briggs And Stratton 11hp
 - Joining Online Reading Communities
 - Participating in Virtual Book Clubs
 - Following Authors and Publishers Manual For Briggs And Stratton 11hp
- 9. Balancing eBooks and Physical Books Manual For Briggs And Stratton 11hp
 - Benefits of a Digital Library
 - Creating a Diverse Reading Collection Manual For Briggs And Stratton 11hp
- 10. Overcoming Reading Challenges
 - Dealing with Digital Eye Strain
 - Minimizing Distractions
 - Managing Screen Time
- 11. Cultivating a Reading Routine Manual For Briggs And Stratton 11hp
 - Setting Reading Goals Manual For Briggs And Stratton 11hp
 - Carving Out Dedicated Reading Time
- 12. Sourcing Reliable Information of Manual For Briggs And Stratton 11hp
 - Fact-Checking eBook Content of Manual For Briggs And Stratton 11hp

- Distinguishing Credible Sources
- 13. Promoting Lifelong Learning
 - Utilizing eBooks for Skill Development
 - Exploring Educational eBooks
- 14. Embracing eBook Trends
 - Integration of Multimedia Elements
 - Interactive and Gamified eBooks

Manual For Briggs And Stratton 11hp Introduction

In today's digital age, the availability of Manual For Briggs And Stratton 11hp books and manuals for download has revolutionized the way we access information. Gone are the days of physically flipping through pages and carrying heavy textbooks or manuals. With just a few clicks, we can now access a wealth of knowledge from the comfort of our own homes or on the go. This article will explore the advantages of Manual For Briggs And Stratton 11hp books and manuals for download, along with some popular platforms that offer these resources. One of the significant advantages of Manual For Briggs And Stratton 11hp books and manuals for download is the cost-saving aspect. Traditional books and manuals can be costly, especially if you need to purchase several of them for educational or professional purposes. By accessing Manual For Briggs And Stratton 11hp versions, you eliminate the need to spend money on physical copies. This not only saves you money but also reduces the environmental impact associated with book production and transportation. Furthermore, Manual For Briggs And Stratton 11hp books and manuals for download are incredibly convenient. With just a computer or smartphone and an internet connection, you can access a vast library of resources on any subject imaginable. Whether you're a student looking for textbooks, a professional seeking industry-specific manuals, or someone interested in self-improvement, these digital resources provide an efficient and accessible means of acquiring knowledge. Moreover, PDF books and manuals offer a range of benefits compared to other digital formats. PDF files are designed to retain their formatting regardless of the device used to open them. This ensures that the content appears exactly as intended by the author, with no loss of formatting or missing graphics. Additionally, PDF files can be easily annotated, bookmarked, and searched for specific terms, making them highly practical for studying or referencing. When it comes to accessing Manual For Briggs And Stratton 11hp books and manuals, several platforms offer an extensive collection of resources. One such platform is Project Gutenberg, a nonprofit organization that provides over 60,000 free eBooks. These books are primarily in the public domain, meaning they can be freely distributed and downloaded. Project Gutenberg offers a wide range of classic literature, making it an excellent resource for literature enthusiasts. Another popular platform for Manual For Briggs And Stratton 11hp books and manuals is Open

Library. Open Library is an initiative of the Internet Archive, a non-profit organization dedicated to digitizing cultural artifacts and making them accessible to the public. Open Library hosts millions of books, including both public domain works and contemporary titles. It also allows users to borrow digital copies of certain books for a limited period, similar to a library lending system. Additionally, many universities and educational institutions have their own digital libraries that provide free access to PDF books and manuals. These libraries often offer academic texts, research papers, and technical manuals, making them invaluable resources for students and researchers. Some notable examples include MIT OpenCourseWare, which offers free access to course materials from the Massachusetts Institute of Technology, and the Digital Public Library of America, which provides a vast collection of digitized books and historical documents. In conclusion, Manual For Briggs And Stratton 11hp books and manuals for download have transformed the way we access information. They provide a cost-effective and convenient means of acquiring knowledge, offering the ability to access a vast library of resources at our fingertips. With platforms like Project Gutenberg, Open Library, and various digital libraries offered by educational institutions, we have access to an ever-expanding collection of books and manuals. Whether for educational, professional, or personal purposes, these digital resources serve as valuable tools for continuous learning and self-improvement. So why not take advantage of the vast world of Manual For Briggs And Stratton 11hp books and manuals for download and embark on your journey of knowledge?

FAQs About Manual For Briggs And Stratton 11hp Books

1. Where can I buy Manual For Briggs And Stratton 11hp books? Bookstores: Physical bookstores like Barnes & Noble, Waterstones, and independent local stores. Online Retailers: Amazon, Book Depository, and various online bookstores offer a wide range of books in physical and digital formats.
2. What are the different book formats available? Hardcover: Sturdy and durable, usually more expensive. Paperback: Cheaper, lighter, and more portable than hardcovers. E-books: Digital books available for e-readers like Kindle or software like Apple Books, Kindle, and Google Play Books.
3. How do I choose a Manual For Briggs And Stratton 11hp book to read? Genres: Consider the genre you enjoy (fiction, non-fiction, mystery, sci-fi, etc.). Recommendations: Ask friends, join book clubs, or explore online reviews and recommendations. Author: If you like a particular author, you might enjoy more of their work.
4. How do I take care of Manual For Briggs And Stratton 11hp books? Storage: Keep them away from direct sunlight and in a dry environment. Handling: Avoid folding pages, use bookmarks, and handle them with clean hands. Cleaning:

- Gently dust the covers and pages occasionally.
5. Can I borrow books without buying them? Public Libraries: Local libraries offer a wide range of books for borrowing. Book Swaps: Community book exchanges or online platforms where people exchange books.
 6. How can I track my reading progress or manage my book collection? Book Tracking Apps: Goodreads, LibraryThing, and Book Catalogue are popular apps for tracking your reading progress and managing book collections. Spreadsheets: You can create your own spreadsheet to track books read, ratings, and other details.
 7. What are Manual For Briggs And Stratton 11hp audiobooks, and where can I find them? Audiobooks: Audio recordings of books, perfect for listening while commuting or multitasking. Platforms: Audible, LibriVox, and Google Play Books offer a wide selection of audiobooks.
 8. How do I support authors or the book industry? Buy Books: Purchase books from authors or independent bookstores. Reviews: Leave reviews on platforms like Goodreads or Amazon. Promotion: Share your favorite books on social media or recommend them to friends.
 9. Are there book clubs or reading communities I can join? Local Clubs: Check for local book clubs in libraries or community centers. Online Communities: Platforms like Goodreads have virtual book clubs and discussion groups.
 10. Can I read Manual For Briggs And Stratton 11hp books for free? Public Domain Books: Many classic books are available for free as they're in the public domain. Free E-books: Some websites offer free e-books legally, like Project Gutenberg or Open Library.

Find Manual For Briggs And Stratton 11hp :

[mcgraw hill answer key science grade 5](#)

[mcdougal geometry chapter10 answer key](#)

[mcgraw hill guided united government government answers](#)

mcgraw hill urban economics solutions manual

mcconnell economics 19e

[mcconnell brue flynn economics 19e](#)

[mcculloch cabrio 260 service manual](#)

mcgraw hill wonders kindergarten sight words

[mccall h4 4002rt refrigerators owners manual](#)

mccormick xtx series tractor workshop service repair diagnostic manual

mcdougal littell algebra resource book practise b
mcdonalds owner operations manual handbook
mcgraw hill geometry study guide answers
mcdonalds team leader development book answers
mcdougal biology guide guide answers

Manual For Briggs And Stratton 11hp :

[june examination scope for tourism grade 12 fda download](#) - Jun 04 2022

web you could buy lead june examination scope for tourism grade 12 or acquire it as soon as feasible you could speedily download this june examination scope for tourism grade 12 after getting deal so next you require the book swiftly you can straight get it its fittingly certainly easy and consequently fats isnt it you have to favor to in

june examination scope for tourism grade 12 pdf download - Jan 31 2022

web june examination scope for tourism grade 12 pdf introduction june examination scope for tourism grade 12 pdf download only business cycles and forecasting lloyd m valentine 1991 measuring student knowledge and skills andreas schleicher 1999 measuring student knowledge and skills a new framework for assessment business

june examination scope for tourism grade 12 uniport edu - Apr 02 2022

web jul 11 2023 not discover the proclamation june examination scope for tourism grade 12 that you are looking for it will certainly squander the time however below next you visit this web page it will be appropriately unconditionally easy to get as skillfully as download lead june examination scope for tourism grade 12

[june examination scope for tourism grade 12 pdf uniport edu](#) - May 03 2022

web sep 16 2023 june examination scope for tourism grade 12 2 7 downloaded from uniport edu ng on september 16 2023 by guest tomorrow s world demographics by 2040 1 4 billion people will be added mostly in africa and south asia economics increased government debt and concentrated economic power will escalate problems for the poor

grade 12 tourism june examination and - Oct 08 2022

web jun 13 2023 good luck grade 12 tourism june examination memorandum is available answer sheet is also included right after question paper in the same document out of 200 marks advised duration is 180 minutes 3 hours there are multiple choice terminology true false

scope of june 2022 exams elimuza com - Aug 18 2023

web jun 2 2022 the scope of the assessments covers the papers in the following subjects no subject this information should be utilised to suitably equip the 2022 cohort to sit for the imminent june assessment sessions yours in education mr jonathan

williams director examinations management accounting

june 2021 examination timetable grade 10 12 tourism - Sep 07 2022

web 8th june 2021 9 00 am 12 00 pm june 2021 examination timetable grade 10 12 life orientation june 2021 examination timetable grade 7 9 life orientation 1 5hr

tourism revision gr 12 t2 2023 learner resource wced - Dec 10 2022

web tourism revision grade 12 tourism term 2 2023 learner resource tourism revision grade 12 tourism term 2 2023 learner resource 2020 nsc examination reports internal moderators reports 2021 gr 12 examination guidelines assessment diagnostic tests general education certificate gec

tourism grade 12 may june mid year exams 2021 previous - Jul 05 2022

web feb 15 2022 why you should pass your tourism grade 12 june exams this year by now every grade 12 tourism student should know that the trial june exams are essential when you apply to study at a university of a college june exams are also very important towards your final grade 12 marks

june examination scope for tourism grade 12 2023 - Apr 14 2023

web june examination scope for tourism grade 12 bulletin of the atomic scientists 1970 06 the bulletin of the atomic scientists is the premier public resource on scientific and technological developments that impact global security founded by manhattan project scientists the bulletin s iconic doomsday clock stimulates solutions for a safer world

tourism grade 12 examination guidelines 2021 - Jun 16 2023

web jun 25 2021 examination guidelines grade 12 2021 1 introduction the curriculum and assessment policy statement caps for engineering graphics and design outlines the nature and purpose of the subject engineering graphics and design this guides the philosophy underlying the teaching and assessment of the subject in grade 12

tourism notes grade 12 tourism grade 12 study guide - Nov 09 2022

web dec 2 2021 tour planning itinerary is a detailed plan of the tourist s journey tourist profile is an indication of the tourists wants and needs element of a client profile name gender age budget nationality location occupation

grade 12 tourism june exam and memo 2023 summaries sa - Feb 12 2023

web grade 12 tourism exam and memo for the june exams this paper consist of 5 sections taking up 24 pages section a short questions section b map work and tour planing foreign exchange section c tourism attractions culture and heritage tourism marketing section d tourism sectors sustainable and responsible tourism section

2022 tourism skills assessment task grade 12 questions - Mar 13 2023

web jun 2 2022 published in 2022 grade 12 assignments more in this category mathematics investigation grade 12 2022 assignments scope of june 2022 exams back to top grade 12 task 2 exemplar tourism skills assessment taskscenario world

heritage site tour itinerary and social media skills teacher

june examination scope for tourism grade 12 download only - Mar 01 2022

web june examination scope for tourism grade 12 5 5 tourism introducing the following key concepts the development of tourism tourism supply and demand sectors involved transport accommodation government the future of tourism including forecasting and future issues affecting the global nature of tourism in a user friendly

2023 24 annual teaching plans tourism grade 12 - Jan 11 2023

web 2023 24 annual teaching plans tourism grade 12 1 2023 24 annual teaching plans tourism grade 12 term 1 term 1 week 1 week 2 week 3 week 4 week 5 week 6 week 7 week 8 week 9 week 10 11 date caps topic introduction domestic regional and international tourism domestic regional and

[tourism grade 12 examination guidelines 2023 pdf](#) - Jul 17 2023

web may 15 2023 to check the tourism grade 12 examination guidelines for 2023 you can visit the website of the department of basic education the website has a section on examination guidelines which includes the tourism grade 12 examination guidelines for 2023 pdf download

grade 12 tourism june exam memo 2022 teacha - May 15 2023

web this product contains downloadable grade 12 tourism exam and memo for june section a short questions section b map work and tour planning foreign exchange section c tourism attractions marketing section b domestic regional and international tourism

june examination scope for tourism grade 12 pdf - Aug 06 2022

web 4 june examination scope for tourism grade 12 2020 06 15 of science the economy should be business is a discipline that has declared its relative independence from economics over time business is a research field that encompasses a wide range of areas ranging from organizational behavior of individuals to the firm s production

june examination scope for tourism grade 12 - Sep 19 2023

web june examination scope for tourism grade 12 a new spin on tourism sep 14 2021 spot on tourism feb 05 2021 course profile feb 17 2022 x kit fet grade 12 geography jan 19 2022 shuters tourism dec 18 2021 hospitality and tourism education standards aug 14 2021 tourist safety and security jul 01 2020

lilitha nursing college online application for 2024 - Aug 01 2022

web oct 12 2023 lilitha nursing college online application 2024 the lilitha nursing college has begun its online application for the 2024 academic year students who have been waiting to apply for study admission space hold the opportunity to complete the forms below is the step by step guide on how to complete the lilitha college of nursing

lilitha college of nursing application form 2023 2024 applysa - Jun 30 2022

web this is where to download the lilitha college of nursing application form 2023 2024 find the instructions for the lilitha college of nursing application form 2023 2024 below read also lilitha college of nursing fees sponsored links lilitha college of nursing online application

[lilitha college of nursing online application 2023 2024](#) - Feb 24 2022

web lilitha college of nursing application 2023 lilitha college of nursing online application form admission entry requirements programme duration prospectus application closing date contact details and fee structure for the 2023 academic year

[lilitha college of nursing online application 2024 pdf](#) - Dec 05 2022

web jan 20 2021 how to apply lilitha college of nursing online application 2024 in order to apply lilitha college of nursing online application you will need the followings a working email address your south african identity number if you are an international applicant your passport number how to registration lilitha college of nursing online

lilitha college of nursing online application 2023 2024 - Aug 13 2023

web the lilitha college of nursing 2023 2024 application can be done both online and offline you can apply online here in order to apply online you will need a working email address and a functional cell phone number or if you are

[lilitha nursing college application forms for 2022 pdf pdffiller](#) - May 30 2022

web students who meet the eligibility criteria set by lilitha nursing college 03 those who wish to apply for admission to lilitha nursing college and fulfill the requirements specified by the college for the application process

lilitha college of nursing application form 2023 2024 - May 10 2023

web the lilitha college of nursing admissions office has made the application form for the 2023 2024 academic year available online for admission to the lilitha college of nursing in 2023 2024 applications from adequately qualified and interested applicants are invited

lilitha college of nursing application forms 2024 - Mar 28 2022

web jun 10 2023 in this page you will be provided with lilitha college of nursing online application 2024 forms available course how to apply and application requirements lilitha college of nursing admission requirements

lilitha college of nursing application forms 2023 2024 - Nov 04 2022

web lilitha college of nursing application forms 2023 2024 muokechidozie admissions lilitha college of nursing will soon begin its online application for the 2024 academic session so if you are a high school leaver or a matric student your chance to apply for a nursing degree is fast approaching

lilitha nursing college application forms for pdf signnow - Sep 02 2022

web lilitha nursing college application forms for 2022 pdf download check out how easy it is to complete and esign documents online using fillable templates and a powerful editor get everything done in minutes

lilitha college of nursing application form 2024 online how to apply - Sep 14 2023

web feb 1 2023 lilitha college of nursing application form 2024 the lilitha college of nursing as well as the south african nursing council sanc online admission application form for prospective candidates that seek admission into the lilitha college of nursing for the 2024 academic year has released

[lilitha nursing college applications 2023 pdf download link - Oct 03 2022](#)

web latest update on 03 10 2023 the official department of the lilitha nursing college has released an online application form for the upcoming admission season 2023 24 in september 2023 and the closing date is not updated yet table of contents

[lilitha nursing college applications 2023 pdf download link lilitha nursing college applications](#)

lilitha college of nursing 2023 intake application infopportunity - Feb 07 2023

web lilitha college of nursing intake application form for the 2023 2024 update is available check procedures on how to apply for the 2023 intake of prospective nurses consider the admission requirements in the table below before applying all applications should be done before the closing date to avoid forfeiting your efforts contents hide

lilitha college of nursing online application form 2023 2024 - Jul 12 2023

web lilitha college of nursing online application 2023 2024 lilitha college of nursing undergraduate and postgraduate online application is released lilitha college of nursing institution has been accredited by the south african nursing council sanc to offer nursing programmes why choose lilitha college of nursing

lilitha college of nursing admission application form 2024 2025 - Apr 28 2022

web oct 2 2023 umtata main campus or thambo districts ngqeleni libode lusikisiki bambisana elliotdale qumbu tsole mclear ugie mthatha and its surrounding rural areas important the lilitha college of nursing application form 2024 is not yet out online disregard any form of advert you come across this page will be updated

lilitha college of nursing application 2024 work and study - Jan 26 2022

web jun 9 2020 lilitha college of nursing application 2024 lilitha college of nursing lcn application 2024 lilitha college of nursing online admission is out for application all applicants who need financial assistance must submit their applications on the nsfas online application system in this page you ll find a breakdown on how to

lilitha college of nursing applications are now open apply today - Mar 08 2023

web oct 14 2022 closing date 31 october 2022 post views 1 238 applications for the three year diploma in nursing r171 the lilitha college of nursing invites applications for basic diploma three year diploma in nursing science from young compassionate and caring individuals who read more

lilitha college of nursing 2023 2024 intake application - Apr 09 2023

web sep 23 2020 lilitha college of nursing 2023 2024 intake application lilitha college of nursing intake application form for

2023 2024 update check procedures on how to apply for the 2023 intake of prospective nurses consider the admission requirements in the table below before applying

[lilitha college of nursing application 2023 2024 - Jan 06 2023](#)

web dec 11 2021 advert is placed on the local newspapers daily dispatch and herald in april may period as well as on the website of the department impumelelo ecprov gov za to invite applications from suitable candidates for all programmes offered at the lilitha college of nursing

[lilitha college of nursing online application 2024 - Jun 11 2023](#)

web apr 10 2023 the lilitha college of nursing 2024 application can be done both online and offline you can apply online here in order to apply online you will need a working email address and a functional cell phone number or if you are an international applicant your passport number

home sidawards - Apr 04 2022

web may 11 2023 the award was established in 2017 recognising the best among the industry s designers with close to 700 entries received annually sida is one of the most intensely contested awards making every winner an outstanding achiever of design excellence showcase galleries for our past recipients have been released visit our

[forms required documents port authority of new york new jersey - Sep 21 2023](#)

web guides new sida application guide pa3253 sida renewal replacement revisions and cancellations form guide pa3253a how to challenge and how to obtain your fbi identity history summary

security identification display area sida study guide - Jan 01 2022

web the port authority of ny nj under guidance of the tsa has developed this training course to familiarize those persons with a need to be in the restricted security identification display area sida as well as the secured and sterile areas of the airport

renewal applicant process port authority of new york new jersey - May 17 2023

web click here to find out where we are located please note airport security id cards expire at midnight 24 00 hours on the date of expiration on the front of the card find all information on the renewal process and the sida renewal replacement revisions and

[sida study guide port authority of new york new jersey - Jun 18 2023](#)

web security identification display area sida study guide every year at airports like jfk ewr lga swf there are real and possible threats to civil aviation security groups and individuals world wide target the aviation industry and other modes of transportation for acts of violence and terrorism

sida badge application newark nj - Jul 07 2022

web the publication as well as sharpness of this sida badge application newark nj can be taken as competently as picked to

act employment and training reporter 1993 the flight attendant career guide tim kirkwood 2014 10 30 for over 20 years this has been the complete guide to the flight attendant career for us and canadian applicants

[sida airport jobs employment in newark nj indeed com](#) - Nov 11 2022

web 39 sida airport jobs available in newark nj on indeed com apply to airport manager security officer agent and more *sida badge application newark nj pdf vps huratips* - May 05 2022

web sida badge application newark nj 1 sida badge application newark nj cargo security legislation airport and business flying directory semiannual report to the congress october 1st 2002 march 31st 2003 2012 2013 class trip directory the encyclopedia of police science mr monk is a mess brothers of the badge come from away usa by rail

[sida badge application newark nj copy](#) - Nov 30 2021

web sida badge application newark nj downloaded from controlplane themintgaming com by guest nickolas lloyd improving the airport customer experience simon and schuster

sida badge application newark nj pdf 2023 status restek wwu - Sep 09 2022

web sida badge application newark nj pdf upload donald s ferguson 2 5 downloaded from status restek wwu edu on september 20 2023 by donald s ferguson tense and sharply satirical novel has become a modern classic and was the basis for two film adaptations san francisco chronicle

sida badge jobs employment in new jersey indeed com - Dec 12 2022

web 9 sida badge jobs available in new jersey on indeed com apply to security officer agent administrator and more

sida logo logo png download iconape com - Feb 02 2022

web sida logo logo vector sida logo icon download as svg transparent png psd pdf ai vector free users also downloaded these svg logos clan k2k cod4 logo democratic unionist party logo dkp peace flag logo epping forest council logo fas forca ativa do servidor logo similar logos

sida sterile area badge application gra gnv com - Feb 14 2023

web social security number optional for sterile area badges tsa badges and federal state and local leos gender address city state zip home phone with area code e mail address date of birth country of birth country of citizenship name of employer job title effective 12 6 2018 non immigrant visa holder provide all of the following

sida badge jobs employment in newark nj indeed com - Apr 16 2023

web 62 sida badge jobs available in newark nj on indeed com apply to security officer analyst operations manager and more [nj ny port authority sida practice questions flashcards](#) - Jan 13 2023

web a sida id is still required to be displayed in the secured area security identification display area sida portions of an airport in which security measures specified in title 49 of the code of federal regulations are carried out

job sida badge jobs employment in newark nj indeed com - Oct 10 2022

web 12 job sida badge jobs available in newark nj on indeed com apply to agent aircraft maintenance technician avionics technician and more

sida badge application newark nj pdf copy red ortax - Jun 06 2022

web sida badge application newark nj pdf introduction sida badge application newark nj pdf copy airport system development 1984 the middle east abstracts and index 2007 foreign air carrier security united states federal aviation administration 1982 lilly reich designer and architect matilda mcquaid 1996 nist sp 800 88 r1

port authority of new york new jersey - Jul 19 2023

web do you need a new sida application guide for the port authority airports download this pdf file to learn about the eligibility requirements and process of obtaining a security identification display area card this guide will help you

sida badge application newark nj pdf copy devy ortax - Aug 08 2022

web sida badge application newark nj pdf introduction sida badge application newark nj pdf copy

new airport security id cards port authority of new york new jersey - Oct 22 2023

web step 1 application complete the secured area access badge airfield driver application or the non secured area access airport employee id badge application form your application must be signed by an authorized company manager who will validate that training and an appropriate background check has been completed step 2 book an

id card fees port authority of new york new jersey - Mar 15 2023

web fingerprint and security threat assessment fee a 110 company check or money order is required for applicants fingerprinted by the airport security id office a 55 company check or money order is required for sida sterile and non sida badges

issuing officer and sida training port authority of new york new jersey - Aug 20 2023

web security identification display area sida training is required at port authority airports with the exception of teterboro airport for individuals who require an airport security id card employees must contact their authorized signatory to schedule training

sida 2021 sids - Mar 03 2022

web sida competition 2021 singapore interior design awards 2021 organised by sids aims to elevate the standards and profiles of interior designers regionally and around the globe and is the only leading interior design awards programme in singapore to be recognised and endorsed by enterprise singapore esg and the designsingapore council dsg