

Types of Motor Control Schematics

Ladder Diagram

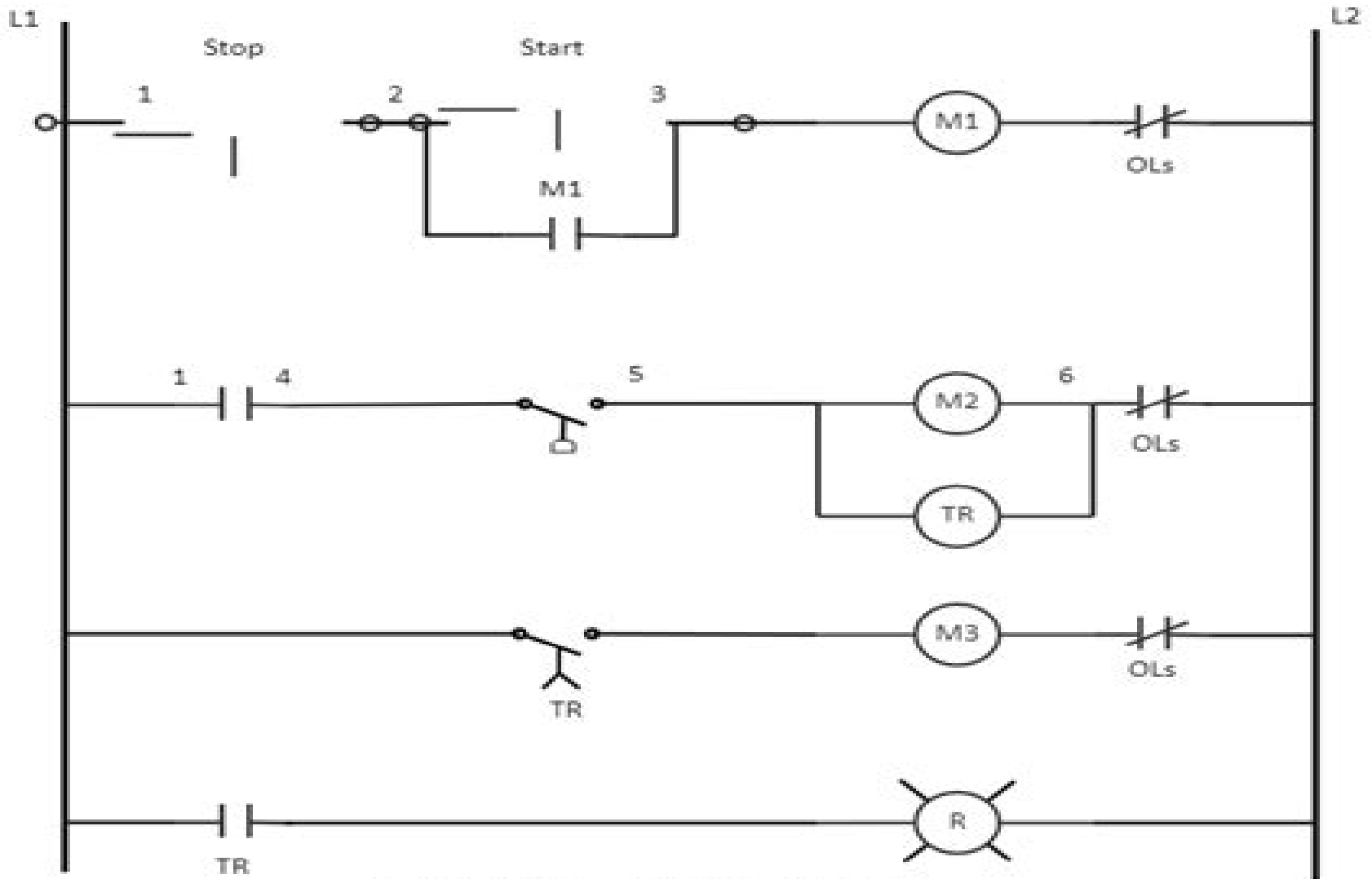

The horizontal line in this ladder diagram are similar to the rungs of a ladder.

Ladder Diagram For Motor Control

William Bolton



Ladder Diagram For Motor Control:

Industrial Electricity and Motor Controls Rex Miller, Mark Miller, 2007-12-14 Dramatically Improve Your Knowledge Base Skills and Applications in Every Area of Industrial Electricity Turn to *Industrial Electricity and Electric Motor Controls* for complete coverage of the entire industrial electrical field—from the basics of electricity to equipment to troubleshooting and repair Packed with over 650 illustrations the latest codes and regulations many study questions and review problems this career building tool shows you how to boost your skills and confidence and then apply this expertise effectively in the workplace It also includes strategies for avoiding common problems and performing proper procedures on every job *Industrial Electricity and Electric Motor Controls* features Learning how to read blueprints schematics schedules site plans as well as mechanical or electrical plans Information on electric motors and their controls Troubleshooting and repair techniques using the ladder diagram or schematic Methods for achieving safety in the workplace A handy glossary of terms A large selection of appendices for reference Inside This Comprehensive Book on Industrial Electricity you will find Tools Safety in the Workplace Symbols Control Circuits and Diagrams Switches Magnetism and Solenoids Relays Motors Timers and Sensors Sensors and Sensing Solenoids and Valves Motor Starting Methods Solid State Reduced Voltage Starters Speed Control and Monitoring Motor Control and Protection Three Phase Controllers Drives Transformers Power Generation Power Distribution Systems Programmable Controllers Troubleshooting and Maintenance *Industrial Electricity as a Career* Appendices DC Motor Trouble Chart Wound Rotor Motor Trouble Chart Fractional Horsepower Motor Trouble Chart Selection of Dual Element Fuses for Motor Running Overload Protection Tables and Formulas Full Load Currents of AC and DC Motors Power Factor Correcting Capacitors Switch Symbols Wiring Diagram Symbols Unit Prefixes Conversion Factors Decibel Table

M2 Instrumentation and Control, Third Edition, [Hands On Water and Wastewater Equipment Maintenance, Volume I](#) Barbara Renner, 2017-12-06 *Hands On Maintenance for Water Wastewater Equipment* deals with equipment maintenance as individual components not as complete machines This allows more information about the design application and maintenance requirements of machinery to be presented The text covers basic operating characteristics of machinery components making it a valuable reference source as well as a training and maintenance manual Written in easy to understand language without complex formulas or technical theories this text provides you with basic information to help you acquire a general understanding of how components function and how to keep equipment operating properly

Wiring Systems and Fault Finding Brian Scaddan, 2008-05-24 The aim of this book is to help the reader approach the drawing and interpretation of electrical diagrams with confidence to understand the principles of testing and to apply this knowledge to fault finding in electrical circuits preface

Control Systems William Bolton, 2002-01-30 Working through this student centred text readers will be brought up to speed with the modelling of control systems using Laplace and given a solid grounding of the pivotal role of control systems across the spectrum of modern engineering A clear readable text is

supported by numerous worked example and problems Key concepts and techniques introduced through applications Introduces mathematical techniques without assuming prior knowledge Written for the latest vocational and undergraduate courses

Pumping Station Design Garr M. Jones PE DEE, Robert L. Sanks PhD PE, 2011-04-19 Pumping Station Design 3e is an essential reference for all professionals From the expert city engineer to the new design officer this book assists those who need to apply the fundamentals of various disciplines and subjects in order to produce a well integrated pumping station that is reliable easy to operate and maintain and free from design mistakes The depth of experience and expertise of the authors contributors and peers reviewing the content as well as the breadth of information in this book is unparalleled making this the only book of its kind An award winning reference work that has become THE standard in the field Dispenses expert information on how to produce a well integrated pumping station that will be reliable easy to operate and maintain and free from design mistakes 60% of the material has been updated to reflect current standards and changes in practice since the book was last published in 1998 New material added to this edition includes the latest design information the use of computers for pump selection extensive references to Hydraulic Institute Standards and much more

Instrumentation and Control Systems William Bolton, 2004-06-03 In a clear and readable style Bill Bolton addresses the basic principles of modern instrumentation and control systems including examples of the latest devices techniques and applications Unlike the majority of books in this field only a minimal prior knowledge of mathematical methods is assumed The book focuses on providing a comprehensive introduction to the subject with Laplace presented in a simple and easily accessible form complimented by an outline of the mathematics that would be required to progress to more advanced levels of study Taking a highly practical approach Bill Bolton combines underpinning theory with numerous case studies and applications throughout to enable the reader to apply the content directly to real world engineering contexts Coverage includes smart instrumentation DAQ crucial health and safety considerations and practical issues such as noise reduction maintenance and testing An introduction to PLCs and ladder programming is incorporated in the text as well as new information introducing the various software programmes used for simulation Problems with a full answer section are also included to aid the reader s self assessment and learning and a companion website for lecturers only at <http://textbooks.elsevier.com> features an Instructor s Manual including multiple choice questions further assignments with detailed solutions as well as additional teaching resources The overall approach of this book makes it an ideal text for all introductory level undergraduate courses in control engineering and instrumentation It is fully in line with latest syllabus requirements and also covers in full the requirements of the Instrumentation Control Principles and Control Systems Automation units of the new Higher National Engineering syllabus from Edexcel Assumes minimal prior mathematical knowledge creating a highly accessible student centred text Problems case studies and applications included throughout with a full set of answers at the back of the book to aid student learning and place theory in real world engineering contexts Free online lecturer resources featuring supporting notes multiple choice

tests lecturer handouts and further assignments and solutions

Introduction to Plant Automation and Controls Raymond F. Gardner, 2020-11-03 *Introduction to Plant Automation and Controls* addresses all aspects of modern central plant control systems including instrumentation control theory plant systems VFDs PLCs and supervisory systems Design concepts and operational behavior of various plants are linked to their control philosophies in a manner that helps new or experienced engineers understand the process behind controls installation programming and troubleshooting of automated systems This groundbreaking book ties modern electronic based automation and control systems to the special needs of plants and equipment It applies practical plant operating experience electronic equipment design and plant engineering to bring a unique approach to aspects of plant controls including security programming languages and digital theory The multidimensional content supported with 500 illustrations ties together all aspects of plant controls into a single source reference of otherwise difficult to find information The increasing complexity of plant control systems requires engineers who can relate plant operations and behaviors to their control requirements This book is ideal for readers with limited electrical and electronic experience particularly those looking for a multidisciplinary approach for obtaining a practical understanding of control systems related to the best operating practices of large or small plants It is an invaluable resource for becoming an expert in this field or as a single source reference for plant control systems Author Raymond F Gardner is a professor of engineering at the U S Merchant Marine Academy at Kings Point New York and has been a practicing engineer for more than 40 years

FUNDAMENTALS OF FAULT CURRENT AND GROUNDING IN ELECTRICAL SYSTEMS HALDEN MORRIS & NORMAN CHAMBERS, 2014-06-30 This book seeks to explain in simple terms the behavior of fault current through the general mass of earth the origin of short circuit current and its value and how a circuit breaker operates The drawings are unique and allow the reader to visualize the behavior of a fault current The book clarifies common myths pertaining to a grounding electrode short circuit and opens neutral conditions and provides an unambiguous understanding of the theoretical and practical explanation for an effective earthing and protective system in electrical installations There are numerous grounding problems and unexplained fault conditions in electrical circuitry that are taken for granted and left unattended for extended periods Potential voltage can be found on the earthing conductors in processing plants refineries and other industrial plants A combination of topics in this book addresses problems that have been adversely affecting the electrical industry for years There are a number of systems in the electrical industry that are common in the workplace but are not understood by the average workman who has to work with these systems daily Systems such as ungrounded systems clean earthing systems motor controls resistance grounding lightning protection systems and Intra earthing systems are all common systems however the knowledge base of these systems is very limited This book highlights the basics of these topics and gives a working overview of these systems The book also discusses the principle of operation of the ground fault circuit interrupter GFCI It is expected that the information provided will allow the reader to visualize various types of GFCIs and the

principle of operation without necessarily having to revert to other text *Instrumentation Sensors* Mr. Rohit Manglik, 2024-07-24 In this book we will study about instrumentation sensors to understand its practical applications and theoretical foundations across scientific and engineering disciplines **Wiring Systems and Fault Finding for Installation Electricians** Brian Scaddan, 2012 This book deals with an area of practice that many students and non electricians find particularly challenging It explains how to interpret circuit diagrams wiring systems and outlines the principles of testing before explaining how to apply this knowledge to fault finding in electrical circuits A handy pocket guide for anybody that needs to be able to trace faults in circuits whether in domestic commercial or industrial settings this book will be extremely useful to electricians plumbers heating engineers and intruder alarm installers **Automation with Programmable Logic Controllers** Peter Rohner, 1996 Facilitates a thorough understanding of the fundamental principles and elements of automated machine control systems Describes mechatronic concepts but highlights PLC machine control and interfacing with the machine s actuators and peripheral equipment Explains methodical design of PLC control circuits and programming and presents solved typical industrial case problems shows how a modern PLC control system is designed structured compiled and commissioned Distributed by ISBS Annotation copyrighted by Book News Inc Portland OR

Electrical Engineering And Automation - Proceedings Of The International Conference On Electrical Engineering And Automation (Eea2016) Xiaoxing Zhang, 2017-04-12 2016 International Conference on Electrical Engineering and Automation EEA2016 was held in Hong Kong China from June 24th 26th 2016 EEA2016 has provided a platform for leading academic scientists researchers scholars and students around the world to get together to compare notes and share their results and findings in areas of Electronics Engineering and Electrical Engineering Materials and Mechanical Engineering Control and Automation Modeling and Simulation Testing and Imaging Robotics Actuating and Sensing The conference had received a total of 445 submissions However after peer review by the Technical Program Committee only 129 were selected to be included in this conference proceedings based on their originality ability to test ideas and contribution to the understanding and advancement in Electronics and Electrical Engineering **Integrating Electrical Systems With Intelligent Computing And Applications** Kiran Thatikonda, 2023-12-21 The emergence of the electron marked a significant milestone in the evolution of Power Generation Grid infrastructure Nanotechnology Analogue Digital electronics and Advanced Electrical Engineering This book succinctly explores this transformative journey from electrons to advanced micro electro mechanical system MEMS applications reshaping the landscape of Electrical Electronics Providing a brief yet comprehensive overview the book delves into the fundamental concepts of electricity It specifically addresses electrical control systems and their diverse applications in industrial and residential contexts The intersection of these electrical systems with intelligent computing methods such as artificial intelligence natural language models data mining and robotics is thoroughly examined Readers will gain valuable insights into the integration of cutting edge

technologies witnessing how these advancements revolutionize the field The book emphasizes the optimization of energy usage the enhancement of automation and the contribution to predictive maintenance Its unique blend of electrical engineering principles and intelligent computing applications positions it as a valuable resource for both newcomers and seasoned professionals in the field

Instinctive Computing Yang Cai,2017-01-09 This book attempts to connect artificial intelligence to primitive intelligence It explores the idea that a genuinely intelligent computer will be able to interact naturally with humans To form this bridge computers need the ability to recognize understand and even have instincts similar to humans The author organizes the book into three parts He starts by describing primitive problem solving discussing topics like default mode learning tool making pheromones and foraging Part two then explores behavioral models of instinctive cognition by looking at the perception of motion and event patterns appearance and gesture behavioral dynamics figurative thinking and creativity The book concludes by exploring instinctive computing in modern cybernetics including models of self awareness stealth visual privacy navigation autonomy and survivability Instinctive Computing reflects upon systematic thinking for designing cyber physical systems and it would be a stimulating reading for those who are interested in artificial intelligence cybernetics ethology human computer interaction data science computer science security and privacy social media or autonomous robots

Industrial Automation David W. Pessen,1991-01-16 The first book to combine all of the various topics relevant to low cost automation Practical approach covers methods immediately applicable to industrial problems showing how to select the most appropriate control method for a given application then design the necessary circuit Focuses on the control circuits and devices electronic electro mechanical or pneumatic used in small to mid size systems Stress is on on off binary control as opposed to continuous feedback analog control Discusses well known procedures and their modifications and a number of original techniques and circuit design methods Covers flexible automation including the use of microcomputers

Programmable Logic Controllers William Bolton,2015-03-06 This textbook now in its sixth edition continues to be straightforward and easy to read presenting the principles of PLCs while not tying itself to one manufacturer or another Extensive examples and chapter ending problems utilize several popular PLCs highlighting understanding of fundamentals that can be used regardless of manufacturer This book will help you to understand the main design characteristics internal architecture and operating principles of PLCs as well as Identify safety issues and methods for fault diagnosis testing and debugging New to This edition A new chapter 1 with a comparison of relay controlled systems microprocessor controlled systems and the programmable logic controller a discussion of PLC hardware and architecture examples from various PLC manufacturers and coverage of security the IEC programming standard programming devices and manufacturer s software More detail of programming using Sequential Function Charts Extended coverage of the sequencer More Information on fault finding including testing inputs and outputs with an illustration of how it is done with the PLC manufacturer s software New case studies A methodical introduction with many illustrations

describing how to program PLCs no matter the manufacturer and how to use internal relays timers counters shift registers sequencers and data handling facilities Consideration of the standards given by IEC 1131 3 and the programming methods of ladder functional block diagram instruction list structured text and sequential function chart Many worked examples multiple choice questions and problems are included with answers to all multiple choice questions and problems given at the end of the book

Instrumentation and Control, 3rd Ed. (M2) American Water Works Association,2001 This operations manual explains the basic principles of electrical power distribution automation and instrumentation in water distribution treatment and storage systems Chapters cover hydraulic and electrical principles electric motor controls measurement instruments and displays pumps and valves and automatic and digital controls

Applied Technology and Instrumentation for Process Control Douglas O. de Sa,2004-01-28 Applied Technology and Instrumentation for Process Control presents the complex technologies of different manufacturing processes and the control instrumentation used The large variety of processes prohibits covering more than a few Carefully selected and diverse but representative examples show how fundamentally basic simpler elements or techn

Three-Phase Electrical Power Joseph E. Fleckenstein,2017-12-19 Three Phase Electrical Power addresses all aspects of three phase power circuits The book treats the transmission of electrical power from the common sources where it is generated to locations where it is consumed At typical facilities where electrical power is used the book covers the important topics of grounding currents power demand metering circuit protection motors motor protection power factor correction tariffs electrical drawings and relays Included in the text are the necessary methods of computing currents and power in all possible types of circuit applications as those that are balanced unbalanced leading lagging three wire and four wire Focusing on electrical gear programs and issues related to the generation and use of three phase electrical power this contemporary educational guide Uses simple straightforward language to explain key concepts and their underlying theory Introduces numerous examples illustrations and photographs to aid in comprehension Employs phasor concepts throughout the text to aid in the analysis of three phase circuits Encourages applied learning by supplying practical problems at the end of each chapter Provides extensive references and a glossary of symbols acronyms and equations Three Phase Electrical Power delivers a much needed modern day treatment of three phase electrical power for electrical engineering students and practitioners alike

Yeah, reviewing a book **Ladder Diagram For Motor Control** could be credited with your close associates listings. This is just one of the solutions for you to be successful. As understood, skill does not recommend that you have astonishing points.

Comprehending as competently as understanding even more than new will pay for each success. next-door to, the statement as with ease as perception of this Ladder Diagram For Motor Control can be taken as with ease as picked to act.

https://staging.conocer.cide.edu/About/Resources/Download_PDFS/Fin260past_Exam_Paper_Answer.pdf

Table of Contents Ladder Diagram For Motor Control

1. Understanding the eBook Ladder Diagram For Motor Control
 - The Rise of Digital Reading Ladder Diagram For Motor Control
 - Advantages of eBooks Over Traditional Books
2. Identifying Ladder Diagram For Motor Control
 - Exploring Different Genres
 - Considering Fiction vs. Non-Fiction
 - Determining Your Reading Goals
3. Choosing the Right eBook Platform
 - Popular eBook Platforms
 - Features to Look for in an Ladder Diagram For Motor Control
 - User-Friendly Interface
4. Exploring eBook Recommendations from Ladder Diagram For Motor Control
 - Personalized Recommendations
 - Ladder Diagram For Motor Control User Reviews and Ratings
 - Ladder Diagram For Motor Control and Bestseller Lists
5. Accessing Ladder Diagram For Motor Control Free and Paid eBooks
 - Ladder Diagram For Motor Control Public Domain eBooks
 - Ladder Diagram For Motor Control eBook Subscription Services

- Ladder Diagram For Motor Control Budget-Friendly Options
- 6. Navigating Ladder Diagram For Motor Control eBook Formats
 - ePub, PDF, MOBI, and More
 - Ladder Diagram For Motor Control Compatibility with Devices
 - Ladder Diagram For Motor Control Enhanced eBook Features
- 7. Enhancing Your Reading Experience
 - Adjustable Fonts and Text Sizes of Ladder Diagram For Motor Control
 - Highlighting and Note-Taking Ladder Diagram For Motor Control
 - Interactive Elements Ladder Diagram For Motor Control
- 8. Staying Engaged with Ladder Diagram For Motor Control
 - Joining Online Reading Communities
 - Participating in Virtual Book Clubs
 - Following Authors and Publishers Ladder Diagram For Motor Control
- 9. Balancing eBooks and Physical Books Ladder Diagram For Motor Control
 - Benefits of a Digital Library
 - Creating a Diverse Reading Collection Ladder Diagram For Motor Control
- 10. Overcoming Reading Challenges
 - Dealing with Digital Eye Strain
 - Minimizing Distractions
 - Managing Screen Time
- 11. Cultivating a Reading Routine Ladder Diagram For Motor Control
 - Setting Reading Goals Ladder Diagram For Motor Control
 - Carving Out Dedicated Reading Time
- 12. Sourcing Reliable Information of Ladder Diagram For Motor Control
 - Fact-Checking eBook Content of Ladder Diagram For Motor Control
 - Distinguishing Credible Sources
- 13. Promoting Lifelong Learning
 - Utilizing eBooks for Skill Development
 - Exploring Educational eBooks
- 14. Embracing eBook Trends

- Integration of Multimedia Elements
- Interactive and Gamified eBooks

Ladder Diagram For Motor Control Introduction

In this digital age, the convenience of accessing information at our fingertips has become a necessity. Whether its research papers, eBooks, or user manuals, PDF files have become the preferred format for sharing and reading documents. However, the cost associated with purchasing PDF files can sometimes be a barrier for many individuals and organizations. Thankfully, there are numerous websites and platforms that allow users to download free PDF files legally. In this article, we will explore some of the best platforms to download free PDFs. One of the most popular platforms to download free PDF files is Project Gutenberg. This online library offers over 60,000 free eBooks that are in the public domain. From classic literature to historical documents, Project Gutenberg provides a wide range of PDF files that can be downloaded and enjoyed on various devices. The website is user-friendly and allows users to search for specific titles or browse through different categories. Another reliable platform for downloading Ladder Diagram For Motor Control free PDF files is Open Library. With its vast collection of over 1 million eBooks, Open Library has something for every reader. The website offers a seamless experience by providing options to borrow or download PDF files. Users simply need to create a free account to access this treasure trove of knowledge. Open Library also allows users to contribute by uploading and sharing their own PDF files, making it a collaborative platform for book enthusiasts. For those interested in academic resources, there are websites dedicated to providing free PDFs of research papers and scientific articles. One such website is Academia.edu, which allows researchers and scholars to share their work with a global audience. Users can download PDF files of research papers, theses, and dissertations covering a wide range of subjects. Academia.edu also provides a platform for discussions and networking within the academic community. When it comes to downloading Ladder Diagram For Motor Control free PDF files of magazines, brochures, and catalogs, Issuu is a popular choice. This digital publishing platform hosts a vast collection of publications from around the world. Users can search for specific titles or explore various categories and genres. Issuu offers a seamless reading experience with its user-friendly interface and allows users to download PDF files for offline reading. Apart from dedicated platforms, search engines also play a crucial role in finding free PDF files. Google, for instance, has an advanced search feature that allows users to filter results by file type. By specifying the file type as "PDF," users can find websites that offer free PDF downloads on a specific topic. While downloading Ladder Diagram For Motor Control free PDF files is convenient, its important to note that copyright laws must be respected. Always ensure that the PDF files you download are legally available for free. Many authors and publishers voluntarily provide free PDF versions of their work, but its essential to be cautious and verify the authenticity of the source before downloading Ladder Diagram For Motor Control. In conclusion,

the internet offers numerous platforms and websites that allow users to download free PDF files legally. Whether its classic literature, research papers, or magazines, there is something for everyone. The platforms mentioned in this article, such as Project Gutenberg, Open Library, Academia.edu, and Issuu, provide access to a vast collection of PDF files. However, users should always be cautious and verify the legality of the source before downloading Ladder Diagram For Motor Control any PDF files. With these platforms, the world of PDF downloads is just a click away.

FAQs About Ladder Diagram For Motor Control Books

How do I know which eBook platform is the best for me? Finding the best eBook platform depends on your reading preferences and device compatibility. Research different platforms, read user reviews, and explore their features before making a choice. Are free eBooks of good quality? Yes, many reputable platforms offer high-quality free eBooks, including classics and public domain works. However, make sure to verify the source to ensure the eBook credibility. Can I read eBooks without an eReader? Absolutely! Most eBook platforms offer webbased readers or mobile apps that allow you to read eBooks on your computer, tablet, or smartphone. How do I avoid digital eye strain while reading eBooks? To prevent digital eye strain, take regular breaks, adjust the font size and background color, and ensure proper lighting while reading eBooks. What the advantage of interactive eBooks? Interactive eBooks incorporate multimedia elements, quizzes, and activities, enhancing the reader engagement and providing a more immersive learning experience. Ladder Diagram For Motor Control is one of the best book in our library for free trial. We provide copy of Ladder Diagram For Motor Control in digital format, so the resources that you find are reliable. There are also many Ebooks of related with Ladder Diagram For Motor Control. Where to download Ladder Diagram For Motor Control online for free? Are you looking for Ladder Diagram For Motor Control PDF? This is definitely going to save you time and cash in something you should think about. If you trying to find then search around for online. Without a doubt there are numerous these available and many of them have the freedom. However without doubt you receive whatever you purchase. An alternate way to get ideas is always to check another Ladder Diagram For Motor Control. This method for see exactly what may be included and adopt these ideas to your book. This site will almost certainly help you save time and effort, money and stress. If you are looking for free books then you really should consider finding to assist you try this. Several of Ladder Diagram For Motor Control are for sale to free while some are payable. If you arent sure if the books you would like to download works with for usage along with your computer, it is possible to download free trials. The free guides make it easy for someone to free access online library for download books to your device. You can get free download on free trial for lots of books categories. Our library is the biggest of these that have literally hundreds of thousands of different products categories represented. You will also see that there are specific sites

catered to different product types or categories, brands or niches related with Ladder Diagram For Motor Control. So depending on what exactly you are searching, you will be able to choose e books to suit your own need. Need to access completely for Campbell Biology Seventh Edition book? Access Ebook without any digging. And by having access to our ebook online or by storing it on your computer, you have convenient answers with Ladder Diagram For Motor Control To get started finding Ladder Diagram For Motor Control, you are right to find our website which has a comprehensive collection of books online. Our library is the biggest of these that have literally hundreds of thousands of different products represented. You will also see that there are specific sites catered to different categories or niches related with Ladder Diagram For Motor Control So depending on what exactly you are searching, you will be able to choose ebook to suit your own need. Thank you for reading Ladder Diagram For Motor Control. Maybe you have knowledge that, people have search numerous times for their favorite readings like this Ladder Diagram For Motor Control, but end up in harmful downloads. Rather than reading a good book with a cup of coffee in the afternoon, instead they juggled with some harmful bugs inside their laptop. Ladder Diagram For Motor Control is available in our book collection an online access to it is set as public so you can download it instantly. Our digital library spans in multiple locations, allowing you to get the most less latency time to download any of our books like this one. Merely said, Ladder Diagram For Motor Control is universally compatible with any devices to read.

Find Ladder Diagram For Motor Control :

fin260past exam paper answer

[fifth grade grammar assessment](#)

fieldnotes the makings of anthropology

[file folder centers language arts grades 4 5](#)

fill in missing fractions on number line

[finacle command manual](#)

[fill in the blanks circulatory system](#)

fifty shades of grey fifty shades book 1

[financial accounting by valix solution manual 2012](#)

[final exam grade 8 2014 memorandum for mathematics](#)

fifty years in the church of rome

[filled older man younger woman eight story collection english edition](#)

fifteen years in hell

[financial accounting by valix 2edition answer key](#)

fiitjee sample papers for class 8 2011

Ladder Diagram For Motor Control :

[le mie mosche artificiali fondamenti di auto cost pdf uniport edu](#) - Jan 28 2022

web may 30 2023 le mie mosche artificiali fondamenti di auto cost 2 7 downloaded from uniport edu ng on may 30 2023 by guest posthumous diary diario postumo eugenio

le mie mosche artificiali fondamenti di auto cost 2023 - Oct 05 2022

web le mie mosche artificiali fondamenti di auto cost concetti di informatica e fondamenti di python jan 13 2023 della vita e degli scritti di orazio ricasoli rucellai nov 11

le mie mosche artificiali fondamenti di auto cost 2 pdf 2023 - Nov 06 2022

web le mie mosche artificiali fondamenti di auto cost 2 pdf upload caliva h ferguson 3 19 downloaded from sgsbenelux internalpublications com on october 8 2023 by caliva h

[le mie mosche artificiali fondamenti di autocostruzione pescare](#) - Apr 11 2023

web buy le mie mosche artificiali fondamenti di autocostruzione pescare con la mosca by pescatori riuniti fishinglab isbn 9798493059087 from amazon s book store

moschee di istanbul wikipedia - Sep 04 2022

web moschee di istanbul istanbul capitale dell impero ottomano dal 1453 e la più grande metropoli del medio oriente comprende un grande numero di moschee nel 2007 si

le moschee di istanbul la cumhuriyet camii di piazza taksim - Mar 30 2022

web dec 27 2012 leggi anche taksim il cuore di istanbul leggi anche la storia del parco gezi di istanbul la moschea di alp la moschea della repubblica è anche altro

le mie mosche artificiali fondamenti di auto cost pdf - Jul 14 2023

web jun 14 2023 le mie mosche artificiali fondamenti di auto cost 2 10 downloaded from uniport edu ng on june 14 2023 by guest italian novel which has for an italian reader

le mie mosche artificiali fondamenti di auto cost pdf uniport edu - Dec 27 2021

web apr 28 2023 mosche artificiali fondamenti di auto cost that you are looking for it will very squander the time however below when you visit this web page it will be fittingly

[amazon it mosche artificiali](#) - Aug 15 2023

web le mie mosche artificiali fondamenti di auto costruzione pescare con la mosca vol 3

le mie mosche artificiali fondamenti di auto cost pdf - Dec 07 2022

web mar 10 2023 le mie mosche artificiali fondamenti di auto cost 2 9 downloaded from uniport edu ng on march 10 2023
by guest exploration of the american west the

ecco le dieci più belle moschee ottomane ad istanbul la luce - Feb 26 2022

web jun 20 2022 la moschea di suleymaniye costruita dal genio dell architettura ottomana mimar sinan è una delle moschee
più belle al mondo situata vicino alla sede imperiale

le mie mosche artificiali fondamenti di auto cost - Apr 30 2022

web aug 2 2023 download and install the le mie mosche artificiali fondamenti di auto cost it is no question easy then since
currently we extend the member to purchase

amazon it recensioni clienti le mie mosche artificiali - May 12 2023

web consultare utili recensioni cliente e valutazioni per le mie mosche artificiali fondamenti di autocostruzione su amazon it
consultare recensioni obiettive e imparziali sui prodotti

le mie mosche artificiali fondamenti di auto costruzione pescare - Mar 10 2023

web le mie mosche artificiali fondamenti di auto costruzione pescare con la mosca vol 3 italian edition ebook pescatori riuniti
fishinglab amazon in kindle store

le mie mosche artificiali fondamenti di auto cost 2022 ftp - Aug 03 2022

web le mie mosche artificiali fondamenti di auto cost the book of disquiet the complete edition psychology from an empirical
standpoint transhumanism engineering the

amazon fr le mie mosche artificiali fondamenti di - Feb 09 2023

web noté 5 retrouvez le mie mosche artificiali fondamenti di autocostruzione et des millions de livres en stock sur amazon fr
achetez neuf ou d occasion

le mie mosche artificiali fondamenti di auto cost - Sep 16 2023

web 4 le mie mosche artificiali fondamenti di auto cost 2020 04 28 carson suggests that a need for brevity influenced the
exactitude and clarity of simonides style and proposes

erdogans denkmal dw 24 08 2013 - Jun 01 2022

web aug 24 2013 in istanbul soll die moschee mit den höchsten minaretten der welt entstehen kritiker des bauprojekts
sehen darin einen schritt in die richtung einer stärker islamisch

yeni camii ovvero la moschea nuova di istanbul - Jul 02 2022

web feb 11 2012 il complesso originario era composto dalla moschea un ospedale una scuola bagni pubblici un mausoleo
due fontane pubbliche e un mercato una

le mie mosche artificiali fondamenti di auto costruzione pescare - Jun 13 2023

web le mie mosche artificiali fondamenti di auto costruzione pescare con la mosca vol 3 ebook pescatori riuniti fishinglab
amazon it kindle store

le mie mosche artificiali fondamenti di auto cost book - Jan 08 2023

web le mie mosche artificiali fondamenti di auto cost book basikbushel com le mie mosche artificiali fondamenti di auto cost
book created date 20220211061708am

le mie mosche artificiali fondamenti di auto cost pdf - Nov 25 2021

web may 21 2023 novels like this le mie mosche artificiali fondamenti di auto cost but end up in malicious downloads rather
than reading a good book with a cup of tea in the

unblocked games 76 google doodle baseball google sites - Sep 09 2023

web there is no game thing thing thing thing 2 thing thing arena thing thing arena 2 this is the only level three goblets thumb
fighter tic tac toe time shooter 2 time

baseball 9 play baseball 9 game online lagged - Jun 25 2022

web free unblocked games at school for kids play games that are not blocked by school addicting games online cool fun from
unblocked games 66 search this site baseball

espn arcade baseball play on crazygames - Mar 03 2023

web baseball games baseball pro game 23775 plays super baseball 33645 plays ultimate baseball 21671 plays baseball kid
pitcher cup 12115 plays extreme baseball 16286

baseball games play on crazygames - Apr 04 2023

web google doodle baseball is a thrilling recreational and captivating sport game that baseball fans and admirers of american
fast foods expect to come across doodle baseball

baseball games unblocked games 66 unblocked games for - Dec 20 2021

super baseball unblocked games pass class room - Feb 19 2022

baseball games online unblocked free play now - May 05 2023

web play baseball pro unblocked online for free simple gameplay excellent graphics no download or registration needed did
you like playing this game

unblocked games baseball games online play - Jul 07 2023

web baseball games online are free browser games for kids that you can play on your pc and mobile phone these sports
games are unblocked for school and no download is

[baseball games online play unblocked at y9freegames.com](#) - May 25 2022

web cool play google doodle baseball unblocked games 66 easy at school we have added only the best unblocked games for school 66 ez to the site our unblocked

backyard baseball play on crazygames - Mar 23 2022

[baseball games unblocked games chrome online games](#) - Jul 27 2022

web this article will take you on a journey through the exhilarating world of baseball simulation shedding light on what makes baseball 9 unblocked such a hit among players of all

google baseball unblocked games online play now mimshacks - Apr 23 2022

[baseball pro play baseball pro on primarygames](#) - Jan 01 2023

web baseball 9 is a fun online sports game that can be played for free on lagged.com play baseball 9 and 1000s of other games in your browser enjoy our hand picked free online

baseball play on crazygames - Jun 06 2023

web play baseball pro unblocked on any device baseball pro online is optimized for use on pc android and ios devices including tablets and mobile phones this game runs

[classroom 6x espn arcade baseball google sites](#) - Aug 08 2023

web espn arcade baseball classroom 6x unblocked games this webpage allows you to play espn arcade baseball unblocked games online for free on chromebook without any

[baseball games play free online baseball games kizi](#) - Aug 28 2022

web super baseball is an online html5 game for play at school and work in this game you have to collect points and buy cool upgrades if you're bored then we recommend to play

unblocked games 66 ez google doodle baseball google sites - Nov 18 2021

baseball 9 unblocked play online now - Jan 21 2022

[baseball games play online games poki](#) - Nov 30 2022

web popular online baseball games 1 mlb the show mlb the show is a simulation game that is exclusive to playstation platforms it is considered as the best baseball game on























baseball pro unblocked games google sites - Oct 30 2022

web g c e a l examinations held in the year 2001 and afterwards contact us location on department of examinations sri lanka pelawatta battaramulla email e mail exams doenets lk ring volume hotline 1911 local phone telephone number 94 11 2786200 quick links exam results

department of examinations sri lanka doenets lk - Feb 02 2022

web the department s website doenets lk telephone 011 2785230 011 3661244 011 3661246 fax 011 2784232 h j m c amith jayasundara commissioner general of examinations 5 5 2 ad 2023 institutional examinations organization branch department of examinations sri lanka pelawatta battaramulla th october 2023

department of examinations sri lanka - Aug 20 2023

web exam results department of examinations sri lanka find your exam results here                      

services department of examinations sri lanka doenets lk - Apr 16 2023

web english conduct of institutional and professional examinations english obtaining of examination results sending results by post g c e o l g c e a l and grade 5 scholarship examinations english rescrutiny of results of g c e o l and g c e a l examinations english issuing certificates for local use or foreign use english

downloads department of examinations sri lanka - Nov 11 2022

web application for a copy of results sheet for private candidates certificates application forms normal service sinhala tamil one day service sinhala

department of examinations sri lanka - Jul 07 2022

web department of examinations sri lanka pelawatta battaramulla sri lanka e mail exams doenets lk hotline 1911 telephone number 94 11 2786200 94 11 2784203 4

department of examinations sri lanka - Jun 18 2023

web limited competitive examination for recruitment to the post of excise inspector of the excise department of sri lanka 2023 600 00 02 oct 2023 08 00 00 am 01 nov 2023 11 59 00 pm gazette

department of examinations sri lanka doenets lk - Jul 19 2023

web are you looking for the 2016 examination results of sri lanka visit doenets lk the official website of the department of examinations and access your grades certificates and verification of results online you can also apply for exams and check the

department of examinations sri lanka - Jun 06 2022

web evaluation reports department of examinations sri lanka prototype questions marking schemes and evaluation reports e c e a l examination 2017 evaluation report 72 tamil tamil 32 business studies sinhala tamil 21 economics sinhala tamil 02

chemistry sinhala tamil 71 sinhala sinhala

exam calendar department of examinations sri lanka - Dec 12 2022

web all institutional examinations which were scheduled to be held from 17th october 2020 have been postponed until further notice due to the covid 19 pandemic situation download

department of examinations sri lanka doenets lk - Sep 21 2023

web department of examinations sri lanka evaluation our services online certificates g c e o l and a l searching the index numbers verification of results exam information centre school exam results other exam results prototype questions marking schemes with question paper and evaluation reports procurement notices

department of examinations sri lanka result doenets lk - May 05 2022

web find your exam results here

department of examinations sri lanka - Mar 15 2023

web nov 26 2021 open competitive examination to recruit graduates to grade 3 1 a of the sri lanka teachers service to teach foreign languages in national schools island wide 2021 limited competitive examination for recruitment to grade iii of public health management assistants service 2021 2021 english

doe apps on google play - Mar 03 2022

web jun 8 2021 about this app welcome to the official mobile application offered by department of examinations sri lanka results of g c e a l examination g c e o l examination grade 5 scholarship examination and other examination can be viewed via this application faster and easier than any other means this application provides the