

HYDRAULIC PUMP (23 cm<sup>3</sup>; 1.4 cu.in.), EXPLODED VIEW  
(WITH THROUGH DRIVE)

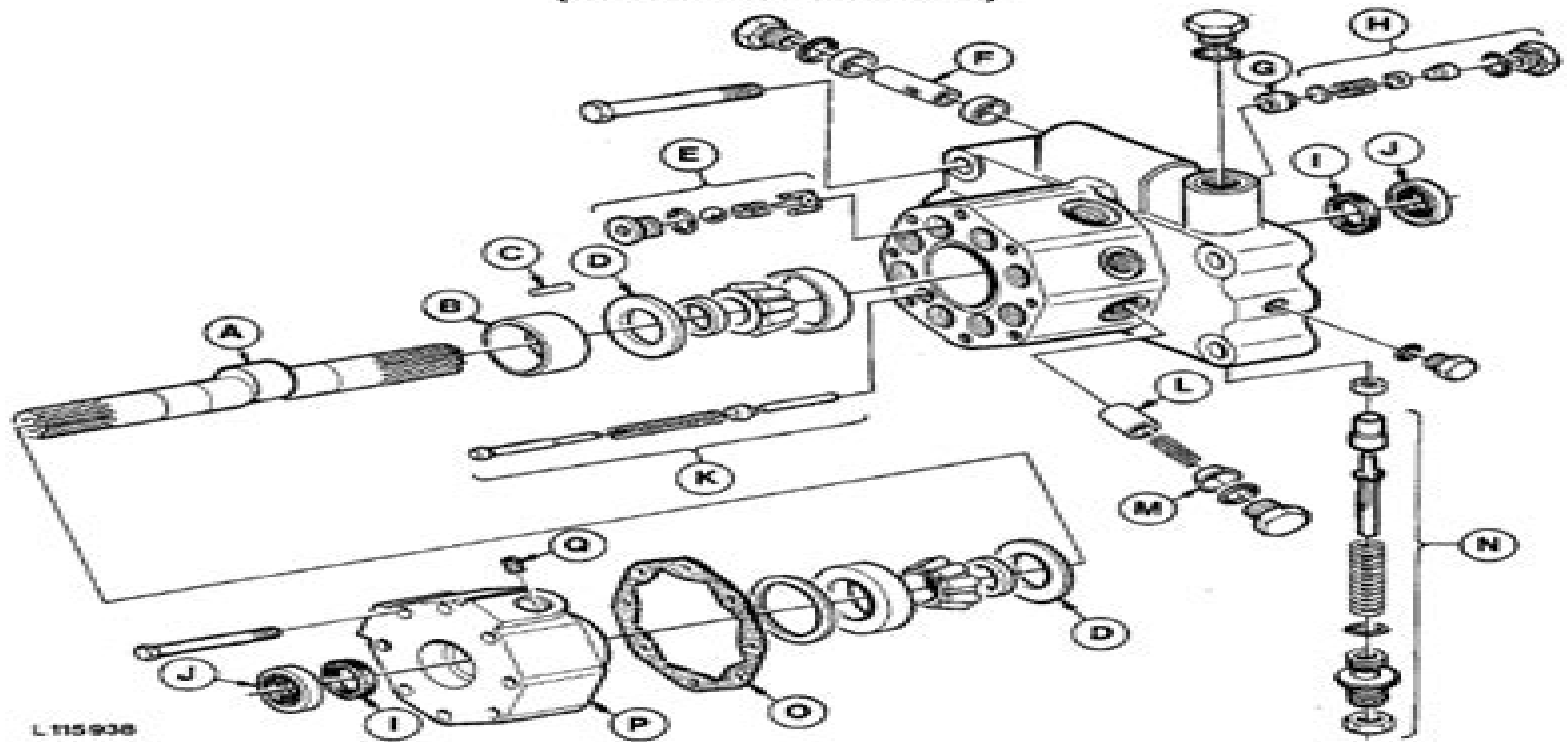

L 115938

- A—Pump shaft
- B—Race
- C—Needle bearing (33 used)
- D—Thrust washer
- E—Inlet valve (3 used)
- F—Filter screen

- G—Valve seat (3 used)
- H—Discharge valve (3 used)
- I—Seal ring
- J—Oil seal
- K—Crankcase outlet valve
- L—Piston (3 used)

- M—Protective sheath (3 used)
- N—Stroke control valve
- O—Gasket
- P—Pump cover
- Q—Orifice plug

L115938-L14701042-010007

# John Deere 3050 Parts Manual

**AW Rasmussen**



## **John Deere 3050 Parts Manual:**

Discover tales of courage and bravery in Crafted by is empowering ebook, Unleash Courage in **John Deere 3050 Parts Manual** . In a downloadable PDF format ( Download in PDF: \*), this collection inspires and motivates. Download now to witness the indomitable spirit of those who dared to be brave.

<https://staging.conocer.cide.edu/files/detail/default.aspx/Literature%20Money%20And%20The%20Market%20From%20Trollope%20To%20Amis.pdf>

## **Table of Contents John Deere 3050 Parts Manual**

1. Understanding the eBook John Deere 3050 Parts Manual
  - The Rise of Digital Reading John Deere 3050 Parts Manual
  - Advantages of eBooks Over Traditional Books
2. Identifying John Deere 3050 Parts Manual
  - Exploring Different Genres
  - Considering Fiction vs. Non-Fiction
  - Determining Your Reading Goals
3. Choosing the Right eBook Platform
  - Popular eBook Platforms
  - Features to Look for in an John Deere 3050 Parts Manual
  - User-Friendly Interface
4. Exploring eBook Recommendations from John Deere 3050 Parts Manual
  - Personalized Recommendations
  - John Deere 3050 Parts Manual User Reviews and Ratings
  - John Deere 3050 Parts Manual and Bestseller Lists
5. Accessing John Deere 3050 Parts Manual Free and Paid eBooks
  - John Deere 3050 Parts Manual Public Domain eBooks
  - John Deere 3050 Parts Manual eBook Subscription Services
  - John Deere 3050 Parts Manual Budget-Friendly Options

6. Navigating John Deere 3050 Parts Manual eBook Formats
  - ePub, PDF, MOBI, and More
  - John Deere 3050 Parts Manual Compatibility with Devices
  - John Deere 3050 Parts Manual Enhanced eBook Features
7. Enhancing Your Reading Experience
  - Adjustable Fonts and Text Sizes of John Deere 3050 Parts Manual
  - Highlighting and Note-Taking John Deere 3050 Parts Manual
  - Interactive Elements John Deere 3050 Parts Manual
8. Staying Engaged with John Deere 3050 Parts Manual
  - Joining Online Reading Communities
  - Participating in Virtual Book Clubs
  - Following Authors and Publishers John Deere 3050 Parts Manual
9. Balancing eBooks and Physical Books John Deere 3050 Parts Manual
  - Benefits of a Digital Library
  - Creating a Diverse Reading Collection John Deere 3050 Parts Manual
10. Overcoming Reading Challenges
  - Dealing with Digital Eye Strain
  - Minimizing Distractions
  - Managing Screen Time
11. Cultivating a Reading Routine John Deere 3050 Parts Manual
  - Setting Reading Goals John Deere 3050 Parts Manual
  - Carving Out Dedicated Reading Time
12. Sourcing Reliable Information of John Deere 3050 Parts Manual
  - Fact-Checking eBook Content of John Deere 3050 Parts Manual
  - Distinguishing Credible Sources
13. Promoting Lifelong Learning
  - Utilizing eBooks for Skill Development
  - Exploring Educational eBooks
14. Embracing eBook Trends
  - Integration of Multimedia Elements

- 
- Interactive and Gamified eBooks

## **John Deere 3050 Parts Manual Introduction**

John Deere 3050 Parts Manual Offers over 60,000 free eBooks, including many classics that are in the public domain. Open Library: Provides access to over 1 million free eBooks, including classic literature and contemporary works. John Deere 3050 Parts Manual Offers a vast collection of books, some of which are available for free as PDF downloads, particularly older books in the public domain. John Deere 3050 Parts Manual : This website hosts a vast collection of scientific articles, books, and textbooks. While it operates in a legal gray area due to copyright issues, its a popular resource for finding various publications. Internet Archive for John Deere 3050 Parts Manual : Has an extensive collection of digital content, including books, articles, videos, and more. It has a massive library of free downloadable books. Free-eBooks John Deere 3050 Parts Manual Offers a diverse range of free eBooks across various genres. John Deere 3050 Parts Manual Focuses mainly on educational books, textbooks, and business books. It offers free PDF downloads for educational purposes. John Deere 3050 Parts Manual Provides a large selection of free eBooks in different genres, which are available for download in various formats, including PDF. Finding specific John Deere 3050 Parts Manual, especially related to John Deere 3050 Parts Manual, might be challenging as theyre often artistic creations rather than practical blueprints. However, you can explore the following steps to search for or create your own Online Searches: Look for websites, forums, or blogs dedicated to John Deere 3050 Parts Manual, Sometimes enthusiasts share their designs or concepts in PDF format. Books and Magazines Some John Deere 3050 Parts Manual books or magazines might include. Look for these in online stores or libraries. Remember that while John Deere 3050 Parts Manual, sharing copyrighted material without permission is not legal. Always ensure youre either creating your own or obtaining them from legitimate sources that allow sharing and downloading. Library Check if your local library offers eBook lending services. Many libraries have digital catalogs where you can borrow John Deere 3050 Parts Manual eBooks for free, including popular titles. Online Retailers: Websites like Amazon, Google Books, or Apple Books often sell eBooks. Sometimes, authors or publishers offer promotions or free periods for certain books. Authors Website Occasionally, authors provide excerpts or short stories for free on their websites. While this might not be the John Deere 3050 Parts Manual full book , it can give you a taste of the authors writing style. Subscription Services Platforms like Kindle Unlimited or Scribd offer subscription-based access to a wide range of John Deere 3050 Parts Manual eBooks, including some popular titles.

---

## FAQs About John Deere 3050 Parts Manual Books

How do I know which eBook platform is the best for me? Finding the best eBook platform depends on your reading preferences and device compatibility. Research different platforms, read user reviews, and explore their features before making a choice. Are free eBooks of good quality? Yes, many reputable platforms offer high-quality free eBooks, including classics and public domain works. However, make sure to verify the source to ensure the eBook credibility. Can I read eBooks without an eReader? Absolutely! Most eBook platforms offer web-based readers or mobile apps that allow you to read eBooks on your computer, tablet, or smartphone. How do I avoid digital eye strain while reading eBooks? To prevent digital eye strain, take regular breaks, adjust the font size and background color, and ensure proper lighting while reading eBooks. What the advantage of interactive eBooks? Interactive eBooks incorporate multimedia elements, quizzes, and activities, enhancing the reader engagement and providing a more immersive learning experience. John Deere 3050 Parts Manual is one of the best book in our library for free trial. We provide copy of John Deere 3050 Parts Manual in digital format, so the resources that you find are reliable. There are also many Ebooks of related with John Deere 3050 Parts Manual. Where to download John Deere 3050 Parts Manual online for free? Are you looking for John Deere 3050 Parts Manual PDF? This is definitely going to save you time and cash in something you should think about.

### Find John Deere 3050 Parts Manual :

*literature money and the market from trollope to amis*

**literaturnoe proizvedenie siuzhet i motiv sbornik nauchnykh trudov**

literary views critical historical ess

**literature of the world an introductory study**

*little music inscribed limited edition*

~~little darlings~~

**little love a little learning**

**little of big bible promises**

*literature at war 1914-1940*

**little bunny kung fu**

**literature and religion forums**

literature and the language arts. the american tradition. program manager

*little golden lamb*

little bobos circus adventure

*little nippers mixing colours - blue*

## **John Deere 3050 Parts Manual :**

**semiramide melodramma tragico in due atti archive org** - Aug 14 2023

web semiramide melodramma tragico in due atti by rossi gaetano 1774 1855 librettist publication date 1857 topics operas librettos publisher milano coi tipi di luigi di

semiramide melodramma tragico in due atti di gaetano rossi - Sep 03 2022

web semiramide melodramma tragico in due atti di gaetano rossi musica di gioachino rossini a cura di philip gossett e alberto zedda author creator rossini gioacchino

*semiramide melodramma tragico in due atti goodreads* - Mar 29 2022

web read reviews from the world s largest community for readers excerpt from semiramide melodramma tragico in due atti satrapi magi babilonesi prin ipess

**semiramide melodramma tragico in due atti classic reprint** - Feb 25 2022

web buy semiramide melodramma tragico in due atti classic reprint by gaetano rossi online at alibris we have new and used copies available in 6 editions starting at

semiramide melodramma tragico in due atti searchworks catalog - Nov 05 2022

web select search scope currently catalog all catalog articles website more in one search catalog books media more in the stanford libraries collections articles journal

**semiramide melodramma tragico in due atti ediz it pdf** - Dec 26 2021

web jul 4 2023 semiramide melodramma tragico in due atti ediz it 2 5 downloaded from uniport edu ng on july 4 2023 by guest and in the early years of semi sovereignty

*semiramide melodramma tragico in due atti di gaetano rossi* - Dec 06 2022

web semiramide melodramma tragico in due atti di gaetano rossi musica del maestro gioachino rossini item preview

**semiramide melodramma tragico in due atti archive org** - Jul 13 2023

web apr 13 2022 semiramide melodramma tragico in due atti by rossi gaetano 1774 1855 librettist

*semiramide melodramma tragico in due atti musica di g rossini* - Feb 08 2023

web acquista semiramide melodramma tragico in due atti musica di g rossini su libreria universitaria spedizione gratuita sopra i 25 euro su libreria universitaria

semiramide melodramma tragico in due atti ediz it copy - Sep 22 2021



---

web may 12 2023 semiramide melodramma tragico in due atti ediz it 2 6 downloaded from uniport edu ng on may 12 2023

by guest the day giuseppe parini 2010 04 01 one of  
*semiramide nell enciclopedia treccani* - Oct 04 2022

web semiramide gr Σειράμις lat semirāmis leggendaria regina assira le cui vicende sono narrate da vari autori greci  
secondo tali narrazioni semiramide fu moglie del re nino e

**semiramide melodramma tragico in due atti classic reprint** - Aug 02 2022

web jul 15 2023 semiramide melodramma tragico in due atti classic reprint gaetano rossi kitabı satın al ingilizce ispanyolca  
almanca rusça arapça kitaplar

**semiramide melodramma tragico in due atti ediz it** - Mar 09 2023

web semiramide melodramma tragico in two acts oct 17 2021 amleto melodramma tragico in two acts and in verse founded  
on shakespeare s hamlet ottavia ballo

**semiramide melodramma tragico in due atti archive org** - Jun 12 2023

web apr 13 2022 semiramide melodramma tragico in due atti by rossi gaetano 1774 1855 librettist

**review semiramide melodramma tragico in due atti di gaetano** - Jan 07 2023

web apr 1 2006 search input search input auto suggest filter your search

*semiramide melodramma tragico in due atti ediz it e* - Jan 27 2022

web semiramide melodramma tragico in due atti ediz it is available in our book collection an online access to it is set as  
public so you can get it instantly our digital library spans in

**semiramide melodramma tragico in due atti ediz it pdf** - Jul 01 2022

web semiramide melodramma tragico in due atti ediz it is available in our digital library an online access to it is set as public  
so you can get it instantly our books collection saves

**semiramide melodramma tragico in due atti musica di g rossini** - May 31 2022

web semiramide melodramma tragico in due atti musica di g rossini è un libro scritto da gaetano rossi pubblicato da casa  
ricordi libraccio it

*semiramide melodramma tragico in due atti ediz it pdf* - Nov 24 2021

web semiramide melodramma tragico in due atti ediz it below the age of mozart and beethoven giorgio pestelli 1984 03 an  
examination of one of the crucial periods of

**semiramide melodramma tragico in due atti ediz it 2023** - May 11 2023

web semiramide melodramma tragico in due atti ediz it il corsaro may 08 2023 although verdi began sketching the music for  
il corsaro in 1846 a lengthy illness forced him to

---

**semiramide melo dramma tragico in due atti classic reprint** - Apr 10 2023

web excerpt from semiramide melo dramma tragico in due atti ma dl applausi clamor giulivo echeggia di lieti suon clamor già la festeggia qual dea nel suo fulgor già s ab

**semiramide wikipedia** - Apr 29 2022

web la regina semiramide dipinto del pittore tortonese cesare saccaggi 1905 françois rabelais nel primo libro di pantagruel inserisce la regina nella lista grottesca di

semiramide melodramma tragico in due atti archive org - Oct 24 2021

web due to a planned power outage on friday 1 14 between 8am 1pm pst some services may be impacted a line drawing of the internet archive headquarters building façade

*savita bhabhi indian porn comics all free episodes in pdf* - Apr 02 2023

web mar 29 2008 all free episodes read and download all free episodes of the savita bhabhi cartoon and xxx apartments comics in pdf and try yourself out if the savita bhabhi membership is worth it if you like our free cartoons you can visit our subscribe page for more comics

savita bhabhi english fsicomics - Sep 26 2022

web read all episodes of savita bhabhi english comics episodes for free at fsicomics read now the latest indian savita bhabhi adult comic in english savita bhabhi is a regular indian woman in the eyes of the world but only a few lucky people know who she really is she is a woman who finds the need to explore her sexuality and enjoy the moment

savita bhabhi episode 75 the father s daughter in law s - Jun 23 2022

web savita bhabhi episode 75 the father s daughter in law s latest chapters free to read

*savita bhabhi all 83 episodes archive org* - Aug 06 2023

web jun 7 2023 2008 topics pornographic cartoon pdf collection opensource language english savita bhabhi is a pornographic cartoon character a housewife published by kirtu her promiscuous behaviour is justified by ashok her husband the title bhabhi sister in law is a respectful term for north indian housewives

**savita bhahi free download borrow and streaming internet** - Sep 07 2023

web may 28 2022 opensource language english savita bhabhi is the first indian porn comics star who is popular since 2009 she keeps you turned on while she enjoys every moment of her sexual adventures addeddate 2022 05 28 18 36 04 identifier savitabhahi identifier ark ark 13960 s24psjv3rq6 ocr tesseract 5 0 0 1 g862e ocr detected lang en

**savita bhabhi all episodes free download pdf video pornogids** - Mar 21 2022

web we hasten to please you you don t have to search for no need to search all over the internet for the desired video below are the best xxx videos with savita bhabhi all episodes free download pdf in high quality exclusively on our website you can

---

see real fuck where the plot has savita bhabhi all episodes free download pdf

[savita bhabhi episode 112 a new life pdf mo8jl4p73v2n](#) - Oct 08 2023

web download view savita bhabhi episode 112 a new life pdf as pdf for free more details pages 141 preview full text loading documents preview related documents more documents from rprafal savita bhabhi episode 112 a new life pdf mo8jl4p73v2n

**download savita bhabhi free pdf oiipdf com** - Nov 28 2022

web download savita bhabhi pdf title savita bhabhi category adult comic language english region india tags adult comics sex comics savita bhabhi comics savita bhabhi indian porn comics format

**download savita bhabhi episode 112 a new life pdf** - Mar 01 2023

web download savita bhabhi episode 112 a new life pdf type pdf date march 2021 size 12 6mb author ghi98183 this document was uploaded by user and they confirmed that they have the permission to share it if you are author or own the copyright of this book please report to us by using this dmca report dmca

[download top 269 savita bhabhi books pdf pdfdrive](#) - May 03 2023

web top 269 savita bhabhi books pdf download free on pdfdrive try now

**savita bhabhi all episode pdf s for free download kevera** - Dec 30 2022

web below you can read and download the free episodes of savita bhabhi comics in pdf and try yourself out if the savita bhabhi membership is worth it if you d like to read more indian porn comics please visit loving and innocent south indian aunty velamma

**savita bhabhi episode 41 village festival comicless** - Oct 28 2022

web savita bhabhi episode 41 village festival adult comics savita bhabhi episode 41 village festival 5 2493 43 author spiesger type porn subscribe read now click

[savita bhabhi archive org](#) - Apr 21 2022

web bhabhi i think i m gonna cum just by licking your pussy you can eat bhabhi s cunt forever and ever beta i don t think can hold it any longer too beta ooooff i don t think i can stay anymore too madam your dick is really digging and exploring my whole pussy i wanted to get a taste of your sweet cunt bhabhi hahal it can t get enough of your

**savita bhabhi indian porn comics official site** - Aug 26 2022

web mar 24 2023 savitabhabhi vip is the official home of your favorite porn comics of savita bhabhi or xxx apartments read indian sex cartoon in english hindi previously at kirtu com

**savita bhabhi savita bhabhi ep 25 the uncle z lib org** - Jul 25 2022

web savita darling after that day uncleji would find new ways to tease savita he wouldn t leave her alone even when ashok was in the house sorry uncle i thought savita was in here a 1 just came for some water qkirtu com

---

[savita bhabhi episode 58 93 download pdf magazines](#) - Jun 04 2023

web apr 21 2020 savita bhabhi episode 58 93 english 34 issues pdf zip 774 3 mb no 91 and 92 issues part 1 savita bhabhi 1 57

**savita bhabhi 8muses sex and porn comics** - Jul 05 2023

web savita bhabhi episode 1 bra salesman savita bhabhi episode 2 the crickett savita bhabhi episode 3 the party savita bhabhi episode 4 visiting cousin savita bhabhi episode 5 servant boy savita bhabhi episode 6 virginity lost savita bhabhi episode 7 doctor doctor savita bhabhi episode 8 the interview















**savita bhabhi episode 100 k2kz9n0emg2y vbook pub** - Jan 31 2023

web overview download view savita bhabhi episode 100 as pdf for free more details words 861 pages 123 preview full text loading documents preview related documents savita bhabhi episode 100 k2kz9n0emg2y 95397 5cb6f35578d6f95397 5cb6f35578d6f page 1 2019 savitabhabhi com

**savita bhabhi free mobile porn xxx sex videos and porno** - Feb 17 2022

web savita bhabhi indian wife ek vehshia runtime 2 min tap to preview download rating 2 8 s1 e1 savita bhabhi fucked her tenant in kitchen room runtime 7 28 touch to watch download rating 3 9 erotic desi bhabhi part 3 runtime 15 min tap to preview download rating 3

**savita bhabhi episode 17**        **2** - May 23 2022

web apr 20 2023 indian comics pdf savita bhabhi episode 17        2 report broken        2 chapter high quality sub indo savita bhabhi sexy adult indian comics free april 20 2023

**ayurveda grundlagen und anwendungen mit ayurvedischer** - Jun 30 2022

web ayurveda grundlagen und anwendungen mit ayurvedischer heilkunde über 50 erkrankungen lindern schrott ernst schachinger wolfgang isbn 9783432116341 kostenloser versand für alle bücher mit versand und verkauf duch amazon

 **ayurveda grundlagen bestandteile und anwendungsgebiete** - Sep 02 2022

web anwendungsgebiete der ayurveda anwendungen ayurveda anwendungen dienen der linderung und heilung verschiedener erkrankungen wie rheuma kopfschmerzen oder stoffwechselstörungen zur anwendung kommt eine ayurveda therapie auch zur vorbeugung und behandlung von verschiedenen funktionellen beschwerden und

**grundlagen ayurveda verband eu** - Mar 28 2022

web ayurveda ist eine komplexe und doch in ihren grundsätzen leicht verständliche heilkunde auf der basis einer ganzheitlichen und universellen philosophie die einzelnen wissenszweige beruhen auf einigen grundlegenden aspekten der wahrnehmung und betrachtung des menschen als individuelle einheit von körper seele und geist

**ayurveda grundlagen und anwendungen mit ayurvedischer** - Jan 06 2023

web ayurveda grundlagen und anwendungen mit ayurvedischer heilkunde über 50 erkrankungen lindern ebook schrott ernst schachinger wolfgang amazon de kindle shop

*ayurveda grundlagen und anwendungen amla natur* - Oct 03 2022

web die ganzheitlich sehr unterschiedlichen und individuellen anwendungen des ayurveda werden hier aufgeführt von heilpflanzen und präparaten über ernährung yoga und meditation bis zu den therapieformen über die sinne wie aroma

**ayurveda basics die grundlagen erklärt paigh** - Sep 14 2023

web jul 22 2019 was ist die dosha lehre die ayurveda lehre setzt bei den fünf elementen wasser luft Äther erde und feuer an alles leben die gesamte natur und so eben auch der mensch setzt sich aus diesen elementen zusammen

*ayurveda grundlagen und anwendungen google books* - Jun 11 2023

web dieses einzigartige handbuch ist ein wichtiges standardwerk zur ayurveda medizin nicht nur für interessierte laien sondern auch für Ärzte und heilpraktiker die autoren vermitteln lebensnah ayurvedische grundlagen und therapien

**handbuch ayurveda grundlagen und anwendungen die** - Dec 05 2022

web handbuch ayurveda grundlagen und anwendungen die traditionelle indische heilweise umfassend und schachinger wolfgang schrott ernst bauhofer ulrich kossatz mathias mittwede martin müller leisgang annette pirc karin schachinger wolfgang schrott ernst schweizer christian amazon de bücher bücher ratgeber

*ayurveda bedeutung und anwendung heilpraxis* - Oct 15 2023

web oct 10 2019 die wichtigsten säulen der ayurvedischen behandlung sind entgiftung und reinigung des körpers physikalische anwendungen wie zum beispiel massagen oder bäder ernährungslehre pflanzliche

**anwendungen prävention schweizer ayurveda verband vsamt** - Feb 24 2022

web ayurveda prävention anwendungen im ayurveda liegt das hauptaugenmerk auf ganzheitlicher gesundheit aus eigener kraft das heisst dass es in erster linie um die erhaltung der gesundheit des gesunden menschen geht nach ayurvedischem verständnis hilft und reguliert sich der körper dank der selbstheilungskräfte selbst

*ayurveda grundlagen und anwendungen by wolfgang* - Aug 01 2022

web sie ist zeitlos denn sie beschreibt die natur des menschen selbst dieses einzigartige werk über ayurvedische heilkunst ist konsequent auf die mitteleuropäische lebenssituation zugeschnitten die autoren vermitteln ihnen lebensnah ayurvedische grundlagen und anwendungen die sie in ihren alltag integrieren können

**ayurveda grundlagen und anwendungen by ernst schrott goodreads** - Nov 04 2022

web ayurveda book read reviews from world s largest community for readers ayurveda ist die weltweit älteste bis heute praktizierte heilmethode sie ist ze

**ayurveda grundlagen und anwendungen kindle ausgabe amazon de** - Feb 07 2023

---

web methodenvielfalt entdecken von jyotish der vedischen astrologie über vaya sthapan und yoga bis hin zu aroma und farbtherapie lernen sie die grundlagen und anwendungen des ayurveda kennen ayurveda ganz praktisch die vielen rezepte Übungen und anwendungen zu den einzelnen methoden können sie sofort für sich umsetzen

**ayurveda grundlagen und anwendungen amazon de** - Aug 13 2023

web lernen sie die grundlagen und anwendungen des ayurveda kennen die Übungen rezepte und anwendungen können sie sofort für sich umsetzen das fundierte heilwissen des ayurveda einstieg erfahren sie mehr über ursprung und geschichte des ayurveda und über das vedische weltbild

ayurveda grundlagen und anwendungen miraherba - Jul 12 2023

web ayurveda die jahrhundertealte heilkunde vereint eine vielfalt an behandlungsmethoden von aroma und farbtherapie über ernährung bis hin zu meditation und yoga dr ernst schrott und dr wolfgang schachinger zwei der bekanntesten Ärzte für maharishi ayurveda in europa zeigen in diesem umfassenden grundlagenwerk ganz praktisch

**ayurveda kompakt erklärt phytodoc** - May 30 2022

web ayurveda bietet halt orientierung und kontrolle und regelt wie eine religion das leben ein schneller blick auf westliche statistiken zeigt übrigens dass religiöse menschen seltener an herz kreislauferkrankungen sterben und auch mit schweren krankheiten oft besser umgehen können

**ayurveda grundlagen und anwendungen** - Apr 28 2022

web gezielte prävention und therapie erfahren sie welche vedischen methoden sie bei über 55 beschwerden wie herz kreislauf störungen erkältungskrankheiten und magen darm problemen einsetzen und kombinieren können erleben sie das reiche wissen des ayurveda und tauchen sie ein in seine faszinierende tradition nur 4 stk an lager

grundlagen schweizer ayurveda verband vsamt - Mar 08 2023

web grundlagen gemäss ayurveda wird der mensch als mikrokosmos und somit als ebenbild des makrokosmos betrachtet das universum mit seinen fünf elementen Äther luft feuer wasser und erde wird im menschlichen organismus widerspiegelt aus den fünf elementen gehen drei sich ergänzende regelsysteme doshas hervor die den menschlichen

eingführung in den ayurveda naturheilverfahren georg - May 10 2023

web eingführung in den ayurveda der ayurveda ist ein großes traditionelles medizinsystem aus indien heutzutage ist der ayurveda hochaktuell weil sich unter seiner logik alle erkrankungen einordnen und behandeln lassen

**ayurveda wikipedia** - Apr 09 2023

web ayurveda oder ayurweda sanskrit म आयुर्वेद āyurveda wissen vom leben von veda wissen ist eine traditionelle indische heilkunst die bis heute viele anwender in indien nepal und sri lanka hat in asien insbesondere in indien wird ayurveda als heilmethode auch akademisch gelehrt und von großen teilen der bevölkerung akzeptiert

