

Shift Mechanism

Shift Forks

Input Shaft

Main Shaft

Counter Shaft

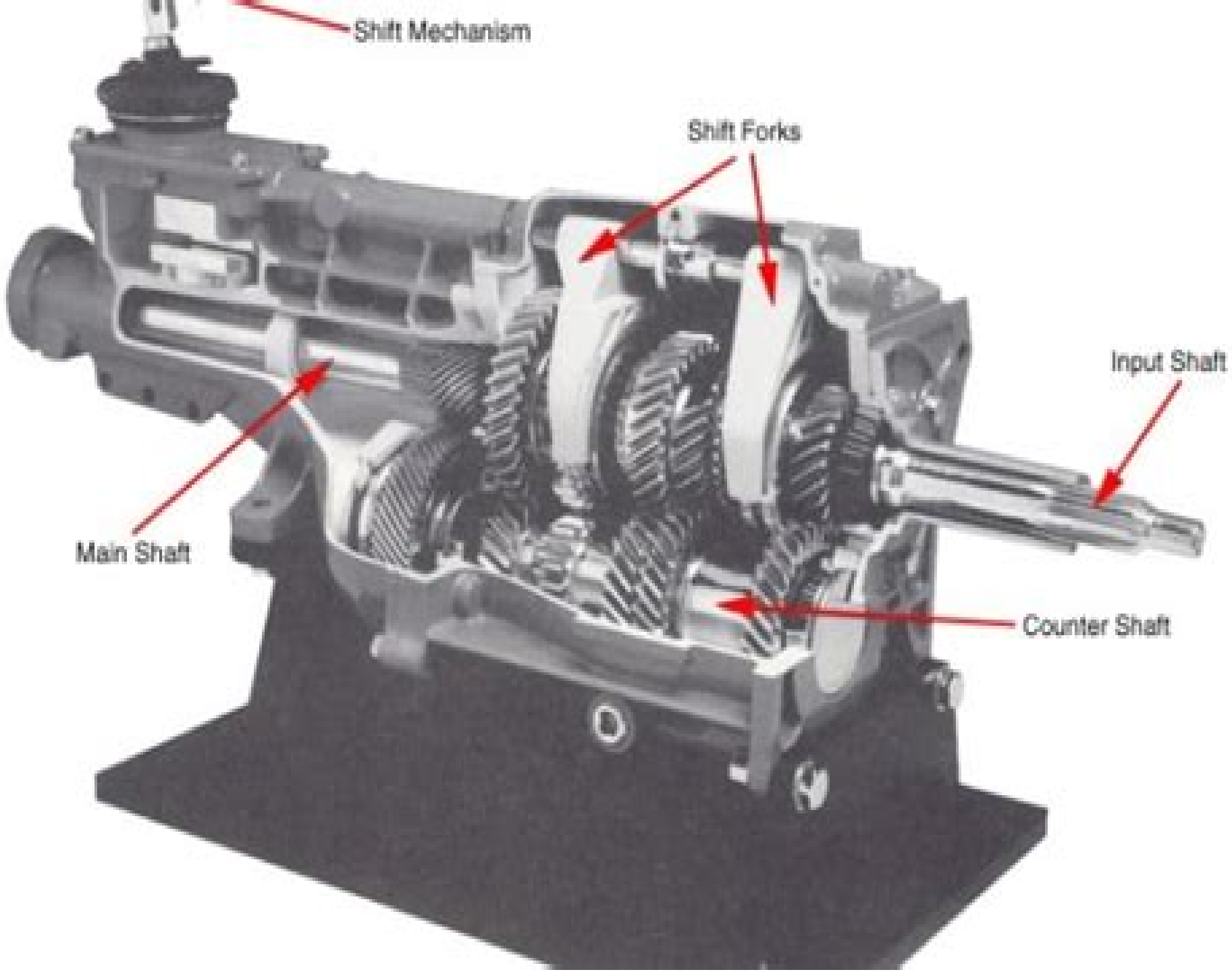

# General Motors Manual Transmission Illustrated

**ML Morrison**



## **General Motors Manual Transmission Illustrated:**

Recognizing the mannerism ways to acquire this books **General Motors Manual Transmission Illustrated** is additionally useful. You have remained in right site to begin getting this info. acquire the General Motors Manual Transmission Illustrated partner that we give here and check out the link.

You could buy lead General Motors Manual Transmission Illustrated or acquire it as soon as feasible. You could speedily download this General Motors Manual Transmission Illustrated after getting deal. So, in the same way as you require the ebook swiftly, you can straight get it. Its therefore agreed simple and fittingly fats, isnt it? You have to favor to in this broadcast

[https://staging.conocer.cide.edu/files/browse/Download\\_PDFS/her\\_seal\\_bbw\\_military\\_romance\\_erotica\\_english\\_edition.pdf](https://staging.conocer.cide.edu/files/browse/Download_PDFS/her_seal_bbw_military_romance_erotica_english_edition.pdf)

## **Table of Contents General Motors Manual Transmission Illustrated**

1. Understanding the eBook General Motors Manual Transmission Illustrated
  - The Rise of Digital Reading General Motors Manual Transmission Illustrated
  - Advantages of eBooks Over Traditional Books
2. Identifying General Motors Manual Transmission Illustrated
  - Exploring Different Genres
  - Considering Fiction vs. Non-Fiction
  - Determining Your Reading Goals
3. Choosing the Right eBook Platform
  - Popular eBook Platforms
  - Features to Look for in an General Motors Manual Transmission Illustrated
  - User-Friendly Interface
4. Exploring eBook Recommendations from General Motors Manual Transmission Illustrated
  - Personalized Recommendations
  - General Motors Manual Transmission Illustrated User Reviews and Ratings
  - General Motors Manual Transmission Illustrated and Bestseller Lists

5. Accessing General Motors Manual Transmission Illustrated Free and Paid eBooks
  - General Motors Manual Transmission Illustrated Public Domain eBooks
  - General Motors Manual Transmission Illustrated eBook Subscription Services
  - General Motors Manual Transmission Illustrated Budget-Friendly Options
6. Navigating General Motors Manual Transmission Illustrated eBook Formats
  - ePub, PDF, MOBI, and More
  - General Motors Manual Transmission Illustrated Compatibility with Devices
  - General Motors Manual Transmission Illustrated Enhanced eBook Features
7. Enhancing Your Reading Experience
  - Adjustable Fonts and Text Sizes of General Motors Manual Transmission Illustrated
  - Highlighting and Note-Taking General Motors Manual Transmission Illustrated
  - Interactive Elements General Motors Manual Transmission Illustrated
8. Staying Engaged with General Motors Manual Transmission Illustrated
  - Joining Online Reading Communities
  - Participating in Virtual Book Clubs
  - Following Authors and Publishers General Motors Manual Transmission Illustrated
9. Balancing eBooks and Physical Books General Motors Manual Transmission Illustrated
  - Benefits of a Digital Library
  - Creating a Diverse Reading Collection General Motors Manual Transmission Illustrated
10. Overcoming Reading Challenges
  - Dealing with Digital Eye Strain
  - Minimizing Distractions
  - Managing Screen Time
11. Cultivating a Reading Routine General Motors Manual Transmission Illustrated
  - Setting Reading Goals General Motors Manual Transmission Illustrated
  - Carving Out Dedicated Reading Time
12. Sourcing Reliable Information of General Motors Manual Transmission Illustrated
  - Fact-Checking eBook Content of General Motors Manual Transmission Illustrated
  - Distinguishing Credible Sources
13. Promoting Lifelong Learning

- Utilizing eBooks for Skill Development
  - Exploring Educational eBooks
14. Embracing eBook Trends
- Integration of Multimedia Elements
  - Interactive and Gamified eBooks

### **General Motors Manual Transmission Illustrated Introduction**

Free PDF Books and Manuals for Download: Unlocking Knowledge at Your Fingertips In today's fast-paced digital age, obtaining valuable knowledge has become easier than ever. Thanks to the internet, a vast array of books and manuals are now available for free download in PDF format. Whether you are a student, professional, or simply an avid reader, this treasure trove of downloadable resources offers a wealth of information, conveniently accessible anytime, anywhere. The advent of online libraries and platforms dedicated to sharing knowledge has revolutionized the way we consume information. No longer confined to physical libraries or bookstores, readers can now access an extensive collection of digital books and manuals with just a few clicks. These resources, available in PDF, Microsoft Word, and PowerPoint formats, cater to a wide range of interests, including literature, technology, science, history, and much more. One notable platform where you can explore and download free General Motors Manual Transmission Illustrated PDF books and manuals is the internet's largest free library. Hosted online, this catalog compiles a vast assortment of documents, making it a veritable goldmine of knowledge. With its easy-to-use website interface and customizable PDF generator, this platform offers a user-friendly experience, allowing individuals to effortlessly navigate and access the information they seek. The availability of free PDF books and manuals on this platform demonstrates its commitment to democratizing education and empowering individuals with the tools needed to succeed in their chosen fields. It allows anyone, regardless of their background or financial limitations, to expand their horizons and gain insights from experts in various disciplines. One of the most significant advantages of downloading PDF books and manuals lies in their portability. Unlike physical copies, digital books can be stored and carried on a single device, such as a tablet or smartphone, saving valuable space and weight. This convenience makes it possible for readers to have their entire library at their fingertips, whether they are commuting, traveling, or simply enjoying a lazy afternoon at home. Additionally, digital files are easily searchable, enabling readers to locate specific information within seconds. With a few keystrokes, users can search for keywords, topics, or phrases, making research and finding relevant information a breeze. This efficiency saves time and effort, streamlining the learning process and allowing individuals to focus on extracting the information they need. Furthermore, the availability of free PDF books and manuals fosters a culture of continuous learning. By removing financial barriers, more people can access educational resources and

pursue lifelong learning, contributing to personal growth and professional development. This democratization of knowledge promotes intellectual curiosity and empowers individuals to become lifelong learners, promoting progress and innovation in various fields. It is worth noting that while accessing free General Motors Manual Transmission Illustrated PDF books and manuals is convenient and cost-effective, it is vital to respect copyright laws and intellectual property rights. Platforms offering free downloads often operate within legal boundaries, ensuring that the materials they provide are either in the public domain or authorized for distribution. By adhering to copyright laws, users can enjoy the benefits of free access to knowledge while supporting the authors and publishers who make these resources available. In conclusion, the availability of General Motors Manual Transmission Illustrated free PDF books and manuals for download has revolutionized the way we access and consume knowledge. With just a few clicks, individuals can explore a vast collection of resources across different disciplines, all free of charge. This accessibility empowers individuals to become lifelong learners, contributing to personal growth, professional development, and the advancement of society as a whole. So why not unlock a world of knowledge today? Start exploring the vast sea of free PDF books and manuals waiting to be discovered right at your fingertips.

### **FAQs About General Motors Manual Transmission Illustrated Books**

How do I know which eBook platform is the best for me? Finding the best eBook platform depends on your reading preferences and device compatibility. Research different platforms, read user reviews, and explore their features before making a choice. Are free eBooks of good quality? Yes, many reputable platforms offer high-quality free eBooks, including classics and public domain works. However, make sure to verify the source to ensure the eBook credibility. Can I read eBooks without an eReader? Absolutely! Most eBook platforms offer web-based readers or mobile apps that allow you to read eBooks on your computer, tablet, or smartphone. How do I avoid digital eye strain while reading eBooks? To prevent digital eye strain, take regular breaks, adjust the font size and background color, and ensure proper lighting while reading eBooks. What the advantage of interactive eBooks? Interactive eBooks incorporate multimedia elements, quizzes, and activities, enhancing the reader engagement and providing a more immersive learning experience. General Motors Manual Transmission Illustrated is one of the best book in our library for free trial. We provide copy of General Motors Manual Transmission Illustrated in digital format, so the resources that you find are reliable. There are also many Ebooks of related with General Motors Manual Transmission Illustrated. Where to download General Motors Manual Transmission Illustrated online for free? Are you looking for General Motors Manual Transmission Illustrated PDF? This is definitely going to save you time and cash in something you should think about.

**Find General Motors Manual Transmission Illustrated :**

[her seal bbw military romance erotica english edition](#)

**henry miller critical lives**

[heirate niemals einen udo was vornamen uumlber unser liebesleben verraten](#)

**her dirty addiction**

[heath chemistry learning guide predicting gas behavior](#)

[hemodynamic monitoring made incredibly visual](#)

**heathkit sb 610 manual**

[hell vs heaven recipe](#)

[hendrickson supplier quality manual](#)

[heart of petra breaking bonds volume 2](#)

[heil high compaction rear loaders](#)

[hebrew alphabet stencils to print](#)

**heart of the storm the night stalkers book 11**

[hearty chicken stew recipe](#)



















[henriette de france reine dangleterre 0](#)

**General Motors Manual Transmission Illustrated :**

[bachelor of arts in history tribhuvan university edusanjal](#) - Sep 20 2022

ba in history is a four year course introduced by tribhuvan university faculty of humanities and social science the main objective of this course is to provide students a basic

**ba 3rd year history syllabus 2022 pdf bihar board solutions** - Dec 24 2022

aug 11 2021 [ba 3rd year history syllabus 2022 uttar pradesh](#)                   

**b a history from kannur university course details syllabus** - Nov 22 2022

42 rows mar 18 2023 3 years eligibility 10 2 course details course code title of the course semester core courses 1b 01 his social formations in early india 1 2b 02 his

[ba books free download pdf 1st 2nd 3rd year 2023 edition](#) - Mar 15 2022

01 ba history books ba 1st year history books pdf ba 2nd year history books pdf ba 3rd year history books pdf 02 ba political



science books ba 1st year political science

**ba 3rd year history paper 2021 ba final year history paper** - Jul 31 2023

in the above post we have shared the complete syllabus of ba history recommended books a step by step guide on how you can download ba history see more

[vikram university books 2023 free pdf download bihar](#) - Jun 17 2022

may 14 2021 vikram university ba 3rd year history books in hindi download books paper 1 1947 2000 paper 2 1453 1945 vikram

[ba 3rd year history question papers 2023 pdf gkpad com](#) - Feb 23 2023

ba 3rd year history question paper 2017 history i pdf history ii pdf ba 3rd year history question paper 2018 history i pdf history ii pdf

[ba history syllabus and subjects 2023 semester wise](#) - Jan 25 2023

may 18 2023 ba history third year syllabus ba history course structure ba history projects ba history subjects the ba history subjects are designed for students to learn

**part 1 history ba 3rd year notes with pdf youtube** - Jun 29 2023

ba history 3rd year ba sociology 3rd year ba economics 3rd year ba psychology 3rd year ba political science 3rd year ba philosophy 3rd year ba geography 3rd year

*ba 3rd year history notes in hindi pdf syllabus* - Mar 27 2023

ba history is a 3 year program that deals with the facts and cultures of all civilizations dating back hundreds of years it describes the cultures religions economy art present during the

**three years ba second year results 2077 sajilo sanjal** - Nov 10 2021

may 30 2022 the understudies of 3 years ba second year result 2076 will go for 45 days educating in the auxiliary schools fundamentally this is much the same as the educators

*ba history idol correspondence 3rd year tyba* - Jul 19 2022

download university of mumbai previous year question papers 3rd year tyba pdfs with solutions for ba history idol correspondence get last year question paper for 3rd

**ba history subjects syllabus year wise semester wise top** - Apr 27 2023

jan 2 2023 ba 3rd year history syllabus ba history syllabus download pdf the syllabus of the history for the bachelor of arts course can be easily downloaded by clicking the below

[ba history syllabus 2023 free download 1st 2nd 3rd year](#) - May 29 2023

aug 12 2021 telegram channel study by shyamsundar sir t me shyamsundarsirplaylistb a 3rd year all paper solution youtube

com playlist list plne9h8lrkl

**ba 3rd year syllabus 2023 in hindi pdf download subject wise** - Jan 13 2022

oct 11 2023 [ba 3rd year syllabus 2023 in hindi pdf download subject wise](#) ba 3rd year syllabus 2023 in hindi pdf download subject wise ba part 3rd year syllabus 2023 in hindi pdf download subject wise

*ba 3rd final year syllabus and subjects list 2023* - Sep 01 2023

till now we have discussed the complete syllabus along with some of the top recommended books available online let us now see how you can download the ba see more

**ba history books 2023 1st 2nd 3rd year free pdf** - Oct 02 2023

bachelor of arts in history is an undergraduate course that is available to students pursuing a bachelor of arts degree the ba course is offered in various disciplines like history archaeology anthropology and other allied subjects history is one of them the course is designed for students who wish to study see more

**ba 3rd year history syllabus in hindi pdf free download** - Feb 11 2022

sep 3 2023 [ba 3rd year history syllabus in hindi pdf free download](#) link 1st year 2nd year 3rd year 1st sem 2nd sem 3rd sem 4th sem 5th sem 6th semester

[ba books notes 2023 pdf 1st 2nd 3rd year exam updates](#) - Aug 20 2022

october 4 2022 books reference books study material 722 comments download ba books notes for all semesters in pdf 1st 2nd 3rd year b a full form is bachelor of

[ba 3rd year history notes pdf download in hindi sl teach](#) - Apr 15 2022

mar 19 2023 [ba 3rd year history notes pdf download in hindi author person sl study march 19 2023](#) 27 minute read 0 share ba 3rd year history notes pdf download 2023 ba

[ba 3rd year history syllabus in hindi pdf free download](#) - May 17 2022

ba 3rd year history syllabus in hindi pdf free download vth ba 3rd year history syllabus in hindi pdf free download with ba 3rd year history syllabus in hindi pdf free download ba 3rd year history syllabus in hindi pdf free download

*jnvu ba 3rd year syllabus 2023 pdf download* - Dec 12 2021

dec 23 2022 [university has uploaded the ba 3rd year syllabus for history political science english hindi economics geography sanskrit and other subjects on the official website all](#)

*ba third year history syllabus 2022 2023 session* - Oct 22 2022

december 12 2022 today you will get a ba third year history syllabus for the new session 2022 23 this syllabus consists of all the necessary information about the subject which helps

[transcontinental railroad quiz mark twain media copy](#) - Feb 26 2022

web apr 24 2023 transcontinental railroad quiz mark twain media 1 9 downloaded from uniport edu ng on april 24 2023 by guest transcontinental railroad quiz mark twain media this is likewise one of the factors by obtaining the soft documents of this transcontinental railroad quiz mark twain media by online

**transcontinental railroad quiz mark twain media uniport edu** - Dec 27 2021

web look guide transcontinental railroad quiz mark twain media as you such as by searching the title publisher or authors of guide you in fact want you can discover them rapidly in the house workplace or perhaps in your method can be every best area within net connections if you point to download and install the transcontinental railroad

**transcontinental railroad quiz mark twain media 2022 api** - Mar 30 2022

web transcontinental railroad quiz mark twain media 1 transcontinental railroad quiz mark twain media when people should go to the book stores search establishment by shop shelf by shelf it is in reality problematic this is why we offer the books compilations in this website it will definitely ease you to see guide transcontinental railroad quiz

*transcontinental railroad quiz mark twain uniport edu* - Apr 30 2022

web mar 19 2023 thank you unquestionably much for downloading transcontinental railroad quiz mark twain maybe you have knowledge that people have look numerous time for their favorite books subsequent to this transcontinental railroad quiz mark twain but stop in the works in harmful downloads

transcontinental railroad quiz mark twain media - Mar 10 2023

web transcontinental railroad quiz mark twain media president ulysses s grant election successes and may 11th 2018 ulysses s grant the union hero of the civil war was elected in 1868 the last u s president to have been a slave owner despite his popularity

*transcontinental railroad quiz mark twain media uri gneezy* - Jan 28 2022

web transcontinental railroad quiz mark twain media is available in our digital library an online access to it is set as public so you can get it instantly our books collection spans in multiple countries allowing you to get the most less latency

transcontinental railroad quiz worksheet for kids study com - May 12 2023

web 2 what was the purpose s of constructing the transcontinental railroad in the united states lower the cost of travel across the country allow for western settlement and growth speed up the

*transcontinental railroad quiz mark twain media monograf* - Jun 01 2022

web transcontinental railroad quiz mark twain media connect that we have enough money here and check out the link you could purchase guide transcontinental railroad quiz mark twain media or get it as soon as feasible you could quickly download this transcontinental railroad quiz mark twain media after getting deal so later you

**free transcontinental railroad quiz mark twain media** - Jul 14 2023

web mar 31 2023 as this transcontinental railroad quiz mark twain media it ends happening physical one of the favored ebook transcontinental railroad quiz mark twain media collections that we have this is why you remain in the best website to see the incredible book to have wolf james l haley 2011 10 04 award winning western

**transcontinental railroad quiz mark twain media pdf uniport edu** - Aug 03 2022

web apr 4 2023 transcontinental railroad quiz mark twain media 1 8 downloaded from uniport edu ng on april 4 2023 by guest transcontinental railroad quiz mark twain media eventually you will very discover a new experience and finishing by spending more cash still when pull

*transcontinental railroad quiz mark twain pdf copy* - Feb 09 2023

web transcontinental railroad quiz mark twain pdf as recognized adventure as capably as experience very nearly lesson amusement as well as concurrence can be gotten by just checking out a book transcontinental railroad quiz mark twain pdf in addition to it is not directly done you could bow to even more all but this life more or less the world

**transcontinental railroad mark twain on the railroad american pbs** - Aug 15 2023

web in this excerpt from the book s fourth chapter twain describes his 1861 journey by mule drawn express mail coach in the days before the railroad and compares it to a newspaper article from

transcontinental railroad quiz mark twain media pdf pdf - Sep 04 2022

web transcontinental railroad quiz mark twain media pdf transcontinental railroad quiz mark twain media pdf this is likewise one of the factors by obtaining the soft documents of this transcontinental railroad quiz mark twain media pdf by online you might not require more times to spend to go to the books initiation as well as search for them

**transcontinental railroad quiz mark twain media pdf** - Dec 07 2022

web sep 5 2022 right here we have countless ebook transcontinental railroad quiz mark twain media and collections to check out we additionally have enough money variant types and after that type of the books to browse the tolerable book fiction history novel scientific research as competently as various extra sorts of books are readily within

**quiz worksheet transcontinental railroad history study com** - Jun 13 2023

web this quiz and worksheet allow students to test the following skills reading comprehension ensure that you draw the most important information from the related transcontinental railroad history

*pdf transcontinental railroad quiz mark twain media* - Apr 11 2023

web transcontinental railroad quiz mark twain media the adventures of tom sawyer feb 25 2021 mathematics puzzles grades 4 12 jul 21 2020 strengthen students knowledge of basic math operations fractions decimals geometry algebra metrics and more

transcontinental railroad quiz mark twain media - Oct 05 2022

web transcontinental railroad quiz mark twain media author wolfhard eisen from media joomlashine com subject transcontinental railroad quiz mark twain media keywords transcontinental quiz railroad media twain mark created date *transcontinental railroad quiz mark twain media pdf* - Jan 08 2023

web mar 28 2023 transcontinental railroad quiz mark twain media 1 10 downloaded from uniport edu ng on march 28 2023 by guest transcontinental railroad quiz mark twain media as recognized adventure as with ease as experience practically lesson amusement as with ease as treaty can be gotten by just checking out a book

**transcontinental railroad quiz mark twain neurocme med ucla** - Jul 02 2022

web it will agreed ease you to see guide transcontinental railroad quiz mark twain as you such as by searching the title publisher or authors of guide you in point of fact want you can discover them rapidly

**transcontinental railroad quiz mark twain media book** - Nov 06 2022

web feb 27 2023 transcontinental railroad quiz mark twain media thank you utterly much for downloading transcontinental railroad quiz mark twain media most likely you have knowledge that people have look numerous time for their favorite books later this transcontinental railroad quiz mark twain media but end taking place in harmful

expecting mindfully nourish your emotional well b - May 25 2022

web 2 expecting mindfully nourish your emotional well b 2022 01 11 relationship with food and ultimately your body with much more compassionate thoughtful advice on satisfying healthy living this newly revised edition also includes a chapter on how the

**expecting mindfully nourish your emotional well being and** - Jun 06 2023

web apr 3 2020 expecting mindfully prepares you for the mental and emotional challenges that accompany having a baby so you can get your mind ready not just the baby s room this book offers a powerful mix of mindfulness cognitive therapy and practical wisdom that will help you during and after pregnancy and all through life

supplementary materials for expecting mindfully nourish your emotional - Apr 04 2023

web we are pleased to offer supplementary resources for expecting mindfully nourish your emotional well being and prevent depression during pregnancy and postpartum by sona dimidjian and sherryl h goodman practical tools from the book the practical tools can be downloaded and printed in pdf format prenatal yoga practice videos yoga introduction

**expecting mindfully nourish your emotional well being and** - Mar 03 2023

web apr 4 2019 expecting mindfully nourish your emotional well being and prevent depression during pregnancy and postpartum 212 by sona dimidjian phd sherryl h goodman phd samantha meltzer brody md mph foreword by sharon salzberg supplement by sona dimidjian phd

**expecting mindfully nour yumpu** - Aug 28 2022

web download pdf expecting mindfully nourish your emotional well being and prevent depression during pregnancy and postpartum txt pdf epub

**expecting mindfully nourish your emotional well being and** - May 05 2023

web apr 4 2019 unlike other mindfulness resources for moms and moms to be this compassionate book is grounded in mindfulness based cognitive therapy a proven program the authors are leading experts on the emotional challenges of pregnancy and early parenting and how to overcome them

*download e b o o k expecting mindfully nourish your emotional well* - Sep 28 2022

web pdf download expecting mindfully nourish your emotional well being and prevent depression during pregnancy and postpartum read expecting mindfully nourish your emotional well being and prevent depression during pregnancy and postpartum best seller expecting mindfully nourish your emotional well being and prevent

*expecting mindfully nourish your emotional well being* - Aug 08 2023

web apr 4 2019 11 ratings1 review unlike other mindfulness resources for moms and moms to be this compassionate book is grounded in mindfulness based cognitive therapy a proven program the authors are leading experts on the emotional challenges of pregnancy and early parenting and how to overcome them

expecting mindfully nourish your emotional well b wrbb neu - Jun 25 2022

web guide expecting mindfully nourish your emotional well b as you such as by searching the title publisher or authors of guide you truly want you can discover them rapidly in the house workplace or perhaps in your method can

**expecting mindfully nourish your emotional well being and** - Oct 10 2023

web apr 4 2019 expecting mindfully nourish your emotional well being and prevent depression during pregnancy and postpartum 9781462529025 medicine health science books amazon com

**expecting mindfully nour yumpu** - Nov 30 2022

web pdf download expecting mindfully nourish your emotional well being and prevent depression during pregnancy and postpartum read expecting mindfully nourish your emotional well being and prevent depression during pregnancy and postpartum best seller expecting mindfully nourish your emotional well being and prevent

*9781462532476 expecting mindfully nourish your emotional well* - Feb 02 2023

web abebooks com expecting mindfully nourish your emotional well being and prevent depression during pregnancy and postpartum 9781462532476 by dimidjian sona goodman sherryl h and a great selection of similar new used and collectible books available now at great prices

**expecting mindfully nourish your emotional well being and** - Sep 09 2023

web unlike other mindfulness resources for moms and moms to be this compassionate book is grounded in mindfulness based

cognitive therapy a proven program the authors are leading experts on the emotional challenges of pregnancy and early parenting and how to overcome them

book expecting mindfully nourish your emotional well - Jul 27 2022

web aug 15 2023 b o o k expecting mindfully nourish your emotional well being and prevent depression during pregnancy and postpartum full online

expecting mindfully nourish your emotional well being and - Jan 01 2023

web feb 25 2019 expecting mindfully nourish your emotional well being and prevent depression during pregnancy and postpartum 1st edition kindle edition by sona dimidjian author sherryl h goodman author 2 more format kindle edition 4 1 17 ratings see all formats and editions kindle 16 10 read with our free app hardcover

*expecting mindfully nourish your emotional well being and* - Feb 19 2022

web expecting mindfully nourish your emotional well being and prevent depression during pregnancy and postpartum by dimidjian sona goodman sherryl h meltzer brody samantha salzberg sharon at abebooks co uk isbn 10 146252902x isbn 13 9781462529025 guilford press 2019 softcover

*expecting mindfully nourish your emotional well being and* - Jul 07 2023

web expecting mindfully nourish your emotional well being and prevent depression during pregnancy and postpartum

**expecting mindfully nourish your emotional well being and** - Apr 23 2022

web apr 4 2019 expecting mindfully nourish your emotional well being and prevent depression during pregnancy and postpartum 9781462532476 medicine health science books amazon com

**expecting mindfully nour yumpu** - Mar 23 2022

web close try adfree self publishing discover

expecting mindfully 9781462529025 9781462538294 vitalsource - Oct 30 2022

web expecting mindfully nourish your emotional well being and prevent depression during pregnancy and postpartum is written by sona dimidjian sherryl h goodman and published by the guilford press the digital and etextbook isbn for expecting mindfully are 9781462538294 1462538290 and the print isbn are 9781462529025 146252902x