

(a)

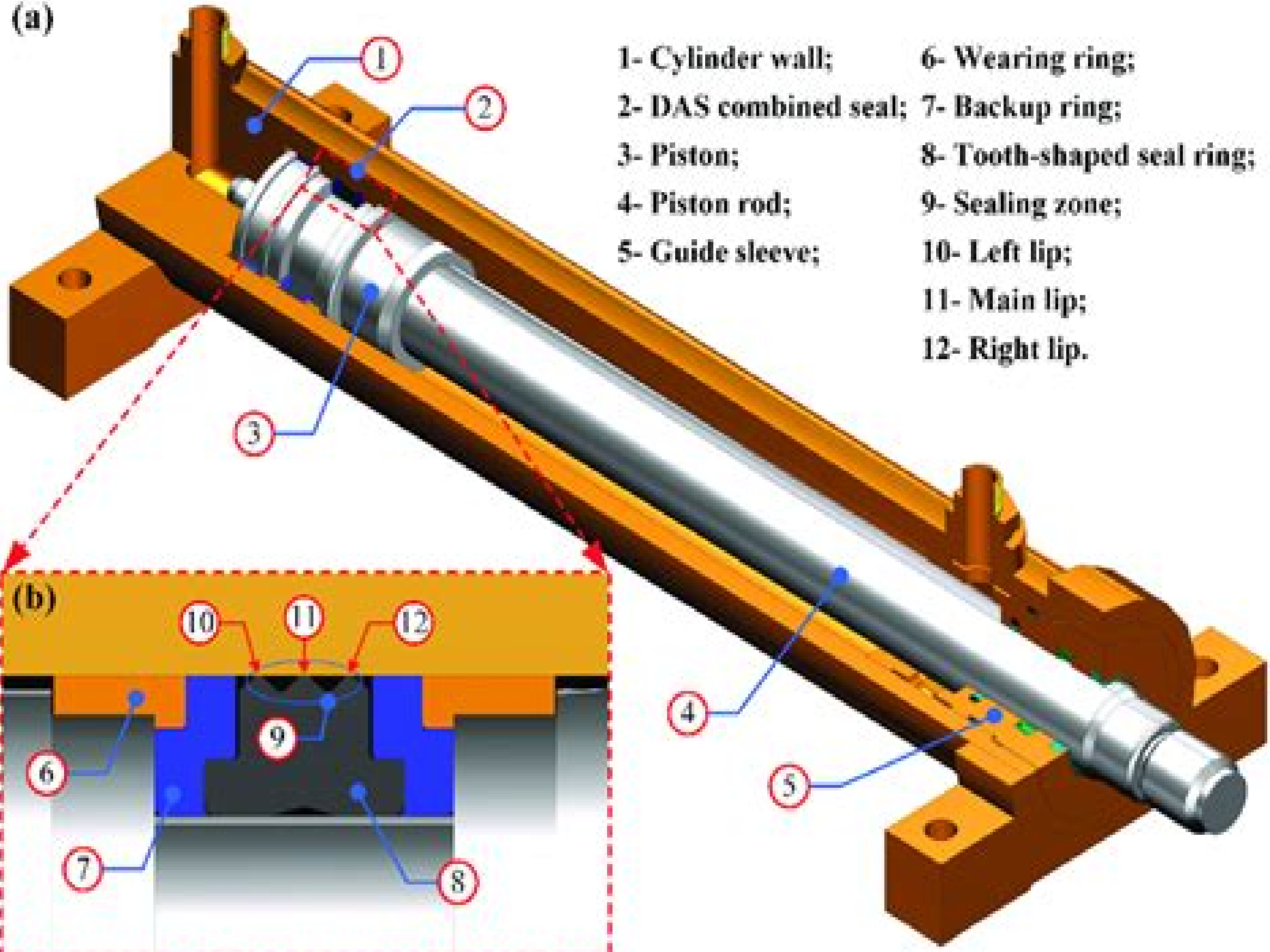

- 1- Cylinder wall;
- 2- DAS combined seal;
- 3- Piston;
- 4- Piston rod;
- 5- Guide sleeve;
- 6- Wearing ring;
- 7- Backup ring;
- 8- Tooth-shaped seal ring;
- 9- Sealing zone;
- 10- Left lip;
- 11- Main lip;
- 12- Right lip.

(b)

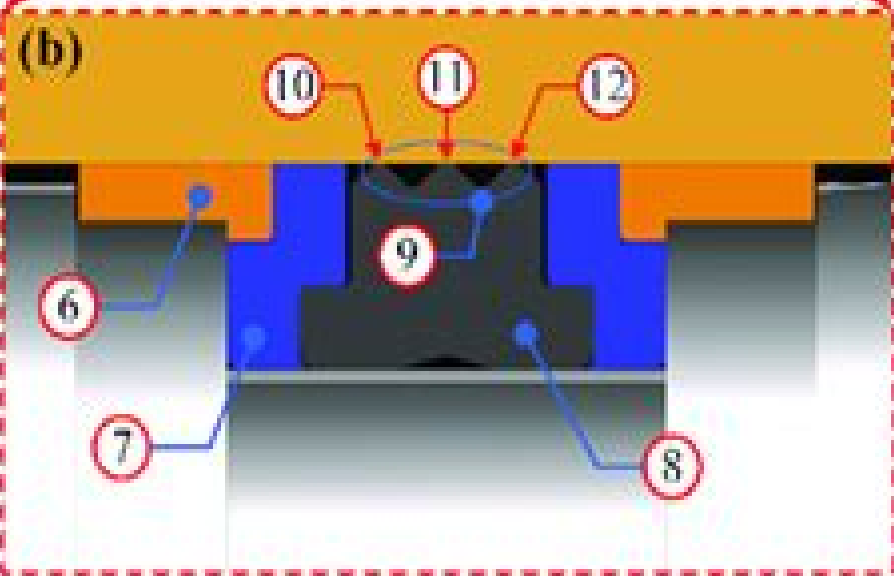

Hydraulic Manual Cylinder Safety Factor

Thomas Griffiths



Hydraulic Manual Cylinder Safety Factor:

Thank you very much for downloading **Hydraulic Manual Cylinder Safety Factor**. Maybe you have knowledge that, people have look hundreds times for their chosen novels like this Hydraulic Manual Cylinder Safety Factor, but end up in infectious downloads.

Rather than reading a good book with a cup of tea in the afternoon, instead they juggled with some harmful virus inside their computer.

Hydraulic Manual Cylinder Safety Factor is available in our book collection an online access to it is set as public so you can get it instantly.

Our books collection spans in multiple locations, allowing you to get the most less latency time to download any of our books like this one.

Kindly say, the Hydraulic Manual Cylinder Safety Factor is universally compatible with any devices to read

https://staging.conocer.cide.edu/files/virtual-library/Download_PDFS/Florida%20Correction%20Officer%20Exam%20Study%20Guide.pdf

Table of Contents Hydraulic Manual Cylinder Safety Factor

1. Understanding the eBook Hydraulic Manual Cylinder Safety Factor
 - The Rise of Digital Reading Hydraulic Manual Cylinder Safety Factor
 - Advantages of eBooks Over Traditional Books
2. Identifying Hydraulic Manual Cylinder Safety Factor
 - Exploring Different Genres
 - Considering Fiction vs. Non-Fiction
 - Determining Your Reading Goals
3. Choosing the Right eBook Platform
 - Popular eBook Platforms
 - Features to Look for in an Hydraulic Manual Cylinder Safety Factor
 - User-Friendly Interface

4. Exploring eBook Recommendations from Hydraulic Manual Cylinder Safety Factor
 - Personalized Recommendations
 - Hydraulic Manual Cylinder Safety Factor User Reviews and Ratings
 - Hydraulic Manual Cylinder Safety Factor and Bestseller Lists
5. Accessing Hydraulic Manual Cylinder Safety Factor Free and Paid eBooks
 - Hydraulic Manual Cylinder Safety Factor Public Domain eBooks
 - Hydraulic Manual Cylinder Safety Factor eBook Subscription Services
 - Hydraulic Manual Cylinder Safety Factor Budget-Friendly Options
6. Navigating Hydraulic Manual Cylinder Safety Factor eBook Formats
 - ePub, PDF, MOBI, and More
 - Hydraulic Manual Cylinder Safety Factor Compatibility with Devices
 - Hydraulic Manual Cylinder Safety Factor Enhanced eBook Features
7. Enhancing Your Reading Experience
 - Adjustable Fonts and Text Sizes of Hydraulic Manual Cylinder Safety Factor
 - Highlighting and Note-Taking Hydraulic Manual Cylinder Safety Factor
 - Interactive Elements Hydraulic Manual Cylinder Safety Factor
8. Staying Engaged with Hydraulic Manual Cylinder Safety Factor
 - Joining Online Reading Communities
 - Participating in Virtual Book Clubs
 - Following Authors and Publishers Hydraulic Manual Cylinder Safety Factor
9. Balancing eBooks and Physical Books Hydraulic Manual Cylinder Safety Factor
 - Benefits of a Digital Library
 - Creating a Diverse Reading Collection Hydraulic Manual Cylinder Safety Factor
10. Overcoming Reading Challenges
 - Dealing with Digital Eye Strain
 - Minimizing Distractions
 - Managing Screen Time
11. Cultivating a Reading Routine Hydraulic Manual Cylinder Safety Factor
 - Setting Reading Goals Hydraulic Manual Cylinder Safety Factor
 - Carving Out Dedicated Reading Time

12. Sourcing Reliable Information of Hydraulic Manual Cylinder Safety Factor
 - Fact-Checking eBook Content of Hydraulic Manual Cylinder Safety Factor
 - Distinguishing Credible Sources
13. Promoting Lifelong Learning
 - Utilizing eBooks for Skill Development
 - Exploring Educational eBooks
14. Embracing eBook Trends
 - Integration of Multimedia Elements
 - Interactive and Gamified eBooks

Hydraulic Manual Cylinder Safety Factor Introduction

In this digital age, the convenience of accessing information at our fingertips has become a necessity. Whether its research papers, eBooks, or user manuals, PDF files have become the preferred format for sharing and reading documents. However, the cost associated with purchasing PDF files can sometimes be a barrier for many individuals and organizations. Thankfully, there are numerous websites and platforms that allow users to download free PDF files legally. In this article, we will explore some of the best platforms to download free PDFs. One of the most popular platforms to download free PDF files is Project Gutenberg. This online library offers over 60,000 free eBooks that are in the public domain. From classic literature to historical documents, Project Gutenberg provides a wide range of PDF files that can be downloaded and enjoyed on various devices. The website is user-friendly and allows users to search for specific titles or browse through different categories. Another reliable platform for downloading Hydraulic Manual Cylinder Safety Factor free PDF files is Open Library. With its vast collection of over 1 million eBooks, Open Library has something for every reader. The website offers a seamless experience by providing options to borrow or download PDF files. Users simply need to create a free account to access this treasure trove of knowledge. Open Library also allows users to contribute by uploading and sharing their own PDF files, making it a collaborative platform for book enthusiasts. For those interested in academic resources, there are websites dedicated to providing free PDFs of research papers and scientific articles. One such website is Academia.edu, which allows researchers and scholars to share their work with a global audience. Users can download PDF files of research papers, theses, and dissertations covering a wide range of subjects. Academia.edu also provides a platform for discussions and networking within the academic community. When it comes to downloading Hydraulic Manual Cylinder Safety Factor free PDF files of magazines, brochures, and catalogs, Issuu is a popular choice. This digital publishing platform hosts a vast collection of publications from around the world. Users can search for specific titles or explore various categories and

genres. Issuu offers a seamless reading experience with its user-friendly interface and allows users to download PDF files for offline reading. Apart from dedicated platforms, search engines also play a crucial role in finding free PDF files. Google, for instance, has an advanced search feature that allows users to filter results by file type. By specifying the file type as "PDF," users can find websites that offer free PDF downloads on a specific topic. While downloading Hydraulic Manual Cylinder Safety Factor free PDF files is convenient, it's important to note that copyright laws must be respected. Always ensure that the PDF files you download are legally available for free. Many authors and publishers voluntarily provide free PDF versions of their work, but it's essential to be cautious and verify the authenticity of the source before downloading Hydraulic Manual Cylinder Safety Factor. In conclusion, the internet offers numerous platforms and websites that allow users to download free PDF files legally. Whether it's classic literature, research papers, or magazines, there is something for everyone. The platforms mentioned in this article, such as Project Gutenberg, Open Library, Academia.edu, and Issuu, provide access to a vast collection of PDF files. However, users should always be cautious and verify the legality of the source before downloading Hydraulic Manual Cylinder Safety Factor any PDF files. With these platforms, the world of PDF downloads is just a click away.

FAQs About Hydraulic Manual Cylinder Safety Factor Books

1. Where can I buy Hydraulic Manual Cylinder Safety Factor books? Bookstores: Physical bookstores like Barnes & Noble, Waterstones, and independent local stores. Online Retailers: Amazon, Book Depository, and various online bookstores offer a wide range of books in physical and digital formats.
2. What are the different book formats available? Hardcover: Sturdy and durable, usually more expensive. Paperback: Cheaper, lighter, and more portable than hardcovers. E-books: Digital books available for e-readers like Kindle or software like Apple Books, Kindle, and Google Play Books.
3. How do I choose a Hydraulic Manual Cylinder Safety Factor book to read? Genres: Consider the genre you enjoy (fiction, non-fiction, mystery, sci-fi, etc.). Recommendations: Ask friends, join book clubs, or explore online reviews and recommendations. Author: If you like a particular author, you might enjoy more of their work.
4. How do I take care of Hydraulic Manual Cylinder Safety Factor books? Storage: Keep them away from direct sunlight and in a dry environment. Handling: Avoid folding pages, use bookmarks, and handle them with clean hands. Cleaning: Gently dust the covers and pages occasionally.
5. Can I borrow books without buying them? Public Libraries: Local libraries offer a wide range of books for borrowing.

- Book Swaps: Community book exchanges or online platforms where people exchange books.
6. How can I track my reading progress or manage my book collection? Book Tracking Apps: Goodreads, LibraryThing, and Book Catalogue are popular apps for tracking your reading progress and managing book collections. Spreadsheets: You can create your own spreadsheet to track books read, ratings, and other details.
 7. What are Hydraulic Manual Cylinder Safety Factor audiobooks, and where can I find them? Audiobooks: Audio recordings of books, perfect for listening while commuting or multitasking. Platforms: Audible, LibriVox, and Google Play Books offer a wide selection of audiobooks.
 8. How do I support authors or the book industry? Buy Books: Purchase books from authors or independent bookstores. Reviews: Leave reviews on platforms like Goodreads or Amazon. Promotion: Share your favorite books on social media or recommend them to friends.
 9. Are there book clubs or reading communities I can join? Local Clubs: Check for local book clubs in libraries or community centers. Online Communities: Platforms like Goodreads have virtual book clubs and discussion groups.
 10. Can I read Hydraulic Manual Cylinder Safety Factor books for free? Public Domain Books: Many classic books are available for free as they're in the public domain. Free E-books: Some websites offer free e-books legally, like Project Gutenberg or Open Library.

Find Hydraulic Manual Cylinder Safety Factor :

florida correction officer exam study guide

[flinn science march madness table answer key](#)

~~flawless web marketing gain money from internet marketing~~

florida fire inspector quiz

fls1502 exam papers

fleetwood terry travel trailer owners manual for 2000 721c ultra light

florida cap study guide

fluid mechanics fluid power engineering ds kumar manual solition

flower dissection data sheet answers

[flashing check engine light audi a4](#)

florida 7th grade civics study guide

[florida science fusion grade 7 assessment guide](#)

~~flat rate manual for man truck~~

~~florida collections textbook answers grade~~

~~florence portraits cour mdicis~~

Hydraulic Manual Cylinder Safety Factor :

manual autodesk inventor 2014 espaol by unarhyne2452 issuu - Jan 31 2023

web sep 25 2017 get manual autodesk inventor 2014 espaol pdf file for free from our online library manual autodesk

inventor 2014 espaol yhatmpagox pdf 60

autodesk inventor 2014 manual espanol stage gapinc - Dec 18 2021

web 4 autodesk inventor 2014 manual espanol 2023 08 24 dramatic changes in food history through an understanding of how these developments sprang from a specific

curso inventor 2014 tutorial autodesk inventor - May 03 2023

web apr 12 2013 peruviantec comperuviantec hotmail com facebook com peruviantec24 cómo instalar el programa inventor 2014 e iniciando por primera

autodesk inventor 2014 manual espanol pdf ittvis - Aug 06 2023

web autodesk inventor 2014 manual espanol downloaded from ittvis com by guest collier adriel lincoln the inventor siu press handbook of visual optics offers an

autodesk inventor 2014 a tutorial introduction google books - Nov 28 2022

web autodesk inventor 2014 a tutorial introduction scott hansen sdc publications 2013 autodesk inventor electronic resource 368 pages this unique text presents a

autodesk inventor 2014 manual espanol 2022 ittvis - Jul 25 2022

web autodesk inventor 2014 manual espanol english mechanic recording for the blind dyslexic catalog of books screen adaptations romeo and juliet world intellectual

autodesk inventor 2013 manual espanol pdf store1 shops widebot - Mar 21 2022

web autodesk inventor 2013 manual espanol downloaded from store1 shops widebot net by guest rivass amir yearbook of international organizations 2013 2014 crc press

manual autodesk inventor 2014 espaol by annahampson1671 - Dec 30 2022

web aug 8 2017 read manual autodesk inventor 2014 espaol by annahampson1671 on issuu and browse thousands of other publications on our platform start here

autodesk community autodesk forums autodesk forum - Jan 19 2022

web we would like to show you a description here but the site won t allow us

read online autodesk inventor 2014 manual espanol pdf free - Mar 01 2023

web sep 12 2023 read online autodesk inventor 2014 manual espanol pdf free copy tutorial guide to autocad 2014 2013 05 29 a tutorial guide to autocad 2014 provides a

autodesk inventor 2013 manual espanol pdf email evius - Jun 23 2022

web autodesk inventor 2013 manual espanol english mechanic and mirror of science and art yearbook of international organizations 2013 2014 language cognition and deafness

autodesk inventor tutorial 2020 youtube - Aug 26 2022

web sep 14 2020 aprende a manejar el software con este tutorial inventor 2020 español sígueme en mis otras redes facebook

autodesk inventor 2020 tutorial en español youtube - Oct 28 2022

web descarga nuestro manual de autodesk inventor 2018 drive google com open id 1tfy bienvenidos esta es una muestra de autodesk inventor 2014 manual espanol mail lafamigliawv com - May 23 2022

web autodesk inventor 2014 manual espanol 3 3 a thorough and yet highly readable style presented chronologically europe a cultural history examines the many cultural

manual in spanish autodesk community - Apr 02 2023

web sep 11 2003 la verdad hay poco de inventor en castellano yo busco mucho por la red y tengo algunas cosas poquitas que te podria enviar tengo en papel un manual del

inventor 2014 curso básico 01 03 09 2013 youtube - Jun 04 2023

web sep 3 2013 curso básico de autodesk inventor profetional 2014 rompiendo el hielo con la primera pieza entorno gráfico procedimientos restricciones y consejos

autodesk inventor professional 2014 indir full program Índir - Feb 17 2022

web autodesk inventor professional 2014 sp1 x86 x64 bit full tam indir autodesk inventor professional 3d cad yazılımıdır 3d mekanik tasarım dökümanitasyon ve ürün

inventor 2014 léame autodesk - Jul 05 2023

web mar 4 2013 si ha instalado autodesk inventor 2011 y 2014 y tiene el control de cuentas de usuario uac activado utilice ejecutar como administrador para cambiar de 2014 a

manual autodesk inventor 2013 español youtube - Oct 08 2023

web oct 2 2014 este es un manual que realice para el aprendizaje y uso del software autodesk inventor 2013 en español pero se adapta perfectamente a cualquier versión del software este manual esta

autodesk inventor 2014 manual espanol dotnbnm - Apr 21 2022

web this unique text and video set presents a thorough introduction to autodesk inventor for anyone with little or no prior experience with cad software it can be used in virtually any

autodesk inventor 2014 manual espanol pdf pdf pdf mautech edu - Sep 26 2022

web autodesk inventor 2014 manual espanol pdf pdf upload donald v williamson 2 6 downloaded from mautech edu ng on november 3 2023 by donald v williamson of real

manual del ingeniero autodesk knowledge network - Sep 07 2023

web el manual del ingeniero es una guía de referencia rápida para disponer de información y fórmulas de cálculo algunos de los materiales son solo de referencia mientras que

stories of ourselves volume 1 cambridge assessment - Nov 06 2022

web description this series contains poetry and prose anthologies composed of writers from across the english speaking world parts of stories of ourselves volume 1 are set for study in cambridge igcse r o level and international as a level literature in english courses

stories of ourselves vol 1 cambridge assessment international - Sep 04 2022

web stories of ourselves vol 1 cambridge assessment international education anthology of stories in english cambridge international igcse en iberlibro com isbn 10 1108462294 isbn 13 9781108462297 cambridge 2019 tapa blanda

stories of ourselves volume 1 cambridge assessment - Mar 10 2023

web stories of ourselves volume 1 cambridge assessment international education anthology of stories in english cambridge international examinations cambridge international igcse by mary wilmer series editor isbn 10 1108462294 isbn 13 9781108462297 cambridge university press 2018 softcover

english literature resources cambridge university press - Jan 28 2022

web parts of songs of ourselves volume 1 are set for study in cambridge igcse o level and cambridge international as a level literature in english syllabuses the anthology includes work from over 100 poets combining famous names such as william wordsworth maya angelou and seamus heaney with lesser known voices

stories of ourselves volume 1 cambridge assessment - Jun 13 2023

web jun 19 2018 this series contains poetry and prose anthologies composed of writers from across the english speaking world parts of stories of ourselves volume 1 are set for study in cambridge igcse o level and international as a

stories of ourselves volume 1 cambridge assessment - Jul 02 2022

web description this series contains poetry and prose anthologies composed of writers from across the english speaking world parts of stories of ourselves volume 1 are set for study in cambridge igcse o level and international as a level literature

in english courses each short story in this collection has its own unique voice and point of view

stories of ourselves volume 1 cambridge assessment - Jun 01 2022

web jun 7 2018 description product details this series contains poetry and prose anthologies composed of writers from across the english speaking world parts of stories of ourselves volume 1 are set for study in cambridge igcse r o level and international as a level literature in english courses

stories of ourselves papacambridge - May 12 2023

web stories of ourselves contains selections of stories set for study for cie s o level igcse as and a level literature in english examinations as with its companion volume songs of ourselves foundation books 2005 the selection goes beyond being a set text though as well as preparing the

english literature resources cambridge university press - Feb 09 2023

web stories of ourselves isbn 9781108436199 format paperback subject s english literature qualification cambridge igcse author s available from march 2018 this series contains poetry and prose anthologies composed of writers from across the english speaking world 14 80 availability in stock add to cart add to wishlist find sales consultant

stories of ourselves volume 1 cambridge assessment - Dec 07 2022

web find 9781108462297 stories of ourselves volume 1 cambridge assessment international education anthology of stories in english by at over 30 bookstores buy rent or sell

stories of ourselves volume 1 cambridge assessment - Jan 08 2023

web jun 7 2018 overview this series contains poetry and prose anthologies composed of writers from across the english speaking world parts of stories of ourselves volume 1 are set for study in cambridge igcse o level and international as a level literature in english courses each short story in this collection has its own unique voice and point

stories of ourselves volume 1 cambridge assessment - Aug 03 2022

web stories of ourselves volume 1 cambridge assessment international education anthology of stories in english cambridge international examinations band 1 wilmer mary isbn 9781108462297 kostenloser versand für alle bücher mit versand und verkauf duch amazon

stories of ourselves volume 1 cambridge university press assessment - Aug 15 2023

web jun 7 2018 parts of stories of ourselves volume 1 are set for study in cambridge igcse o level and international as a level literature in english courses each short story in this collection has its own unique voice and point of view they may differ in form genre style tone and origin but all have been chosen because of their wide appeal

english literature resources cambridge university press - Jul 14 2023

web description parts of stories of ourselves volume 1 are set for study in cambridge igcse o level and international as a level

literature in english courses each short story in this collection has its own unique voice and point of view

english literature resources cambridge university press - Dec 27 2021

web stories of ourselves is a set text for the cambridge literature in english courses at igcse o level as and a level the anthology contains stories by writers from many different countries and cultures

stories of ourselves cambridge assessment international - Oct 05 2022

web stories of ourselves cambridge assessment international education anthology of stories in english cambridge international examinations mary wilmer amazon com tr kitap

stories of ourselves volume 1 cambridge assessment alibris - Apr 30 2022

web buy stories of ourselves volume 1 cambridge assessment international education anthology of stories in english online at alibris we have new and used copies available in 1 editions starting at 9 68 shop now

loading interface goodreads - Feb 26 2022

web discover and share books you love on goodreads

stories of ourselves volume 1 cambridge assessment - Apr 11 2023

web stories of ourselves volume 1 cambridge assessment international education anthology of stories in english cambridge international examinations cambridge international igcse amazon co uk wilmer mary 9781108462297 books young adult education reference foreign language study buy new 14 80 free returns free

stories of ourselves cambridge assessment international - Mar 30 2022

web stories of ourselves cambridge assessment international education anthology of stories in english cambridge international igcse paperback 31 mar 2018 by mary wilmer editor 4 7 85 ratings part of cambridge international igcse english 4 books see all formats and editions





oxford spell it yourself assets bracketcloud com - May 04 2022

web oxford spell it yourself reviewing oxford spell it yourself unlocking the spellbinding force of linguistics in a fast paced world fueled by information and interconnectivity the spellbinding force of linguistics has acquired newfound prominence its capacity to evoke emotions stimulate contemplation and

oxford spell it yourself pdf wiki lwn - May 16 2023

web oxford spell it yourself unveiling the energy of verbal art an emotional sojourn through oxford spell it yourself in a world inundated with displays and the cacophony of immediate communication the profound

oxford spell it yourself        - Sep 08 2022

web  oxford spell it yourself    

[oxford spell it yourself abebooks](#) - Feb 13 2023

web isbn 9780199111237 paperback condition very good the book has been read but is in excellent condition pages are intact and not marred by notes or highlighting the spine remains undamaged oxford spell it yourself

oxford spell it yourself by not available paperback - Jun 05 2022

web find many great new used options and get the best deals for oxford spell it yourself by not available paperback 2003 at the best online prices at ebay free delivery for many products

[oxford spell it yourself](#) - Jul 06 2022

web [oxford spell it yourself](#) amazon ae [oxford spell it yourself](#) amazon ae [oxford spell it yourself](#) amazon ae [oxford spell it yourself](#) amazon ae [oxford spell it yourself](#) amazon ae

oxford popular school dictionary export paperback - Mar 02 2022

web sep 5 2002 buy oxford popular school dictionary export by delahunty andrew macdonald fred isbn 9780199111237 from amazon s book store everyday low prices and free delivery on eligible orders oxford popular school dictionary export amazon co uk delahunty andrew macdonald fred 9780199111237 books

oxford spell it yourself forms imcost edu in - Aug 07 2022

web spell it yourself g t hawker 2003 spell it yourself is designed for children to find correct spellings quickly and easily without the distraction of complicated meanings and definitions found in a dictionary lists over 8000 root words and their derivatives motivates children to look up words for themselves

oxford spelling wikipedia - Apr 15 2023

web oxford spelling also oxford english dictionary spelling oxford style or oxford english spelling is a spelling standard named after its use by the university of oxford that prescribes the use of british spelling in combination with the suffix ize in words like realize and organization in contrast to use of ise endings oxford spelling is used by many

[oxford spell it yourself by amazon ae](#) - Jul 18 2023

web buy oxford spell it yourself by online on amazon ae at best prices fast and free shipping free returns cash on delivery available on eligible purchase

[oxford spell it yourself amazon sg books](#) - Jan 12 2023

web hello sign in account lists returns orders cart

oxford spell it yourself từ sách học ngoại ngữ - Oct 09 2022

web oct 10 2019 spell it yourself is designed for children to find correct spellings quickly and easily without the distraction of complicated meanings and definitions found in a dictionary title oxford spell it yourself isbn 0198341350 author g t hawker publisher london oxford university press year 1981 language english paperback 148 size

oxford spell it yourself help environment harvard edu - Feb 01 2022

web midst of them is this oxford spell it yourself that can be your partner british books 1962 oxford english dictionary john simpson 2000 the ultimate authority on the usage and meaning of english words and phrases unparalleled in its accuracy and comprehensiveness the oxford english dictionary is the supreme reference work for

spell it yourself hawker g t amazon co uk books - Sep 20 2023

web jun 26 2003 4 8 18 ratings see all formats and editions paperback 2 66 13 used from 0 01 1 collectible from 35 95 spell it yourself is designed for children to find correct spellings quickly and easily without the distraction of complicated meanings and definitions found in a dictionary

oxford spell it yourself solutions milnerbrowne com - Jun 17 2023

web 4 oxford spell it yourself 2023 03 16 of individual education plans and will appeal to sencos and teachers and assistants working with the updated code of practice providing additional support at school level and school action plus part three the step by step programme details a systematic approach to learning letter sounds and











oxford spell it yourself book ebay - Dec 11 2022

web dec 12 2022 find many great new used options and get the best deals for oxford spell it yourself book at the best online prices at ebay free delivery for many products

oxford spell it yourself wiki lwn net - Nov 10 2022

web kindly say the oxford spell it yourself is universally compatible with any devices to read new oxford dictionary for writers and editors oxford oxford languages 2014 the new oxford dictionary for writers and editors is the essential a to z guide for everyone who works with words drawing on the expertise of

oxford spell it yourself kolelkutub com - Apr 03 2022

web oxford spell it yourself     3        

oxford spell it yourself wiki lwn net - Aug 19 2023

web unveiling the power of verbal artistry an psychological sojourn through oxford spell it yourself in a world inundated with monitors and the cacophony of fast interaction the profound energy and emotional resonance of verbal beauty usually diminish into obscurity eclipsed by the regular

oxford spell it yourself hachette childrens books - Mar 14 2023

web oxford spell it yourself hachette childrens books used good book eur 2 85 in vendita authors hachette childrens books oxford spell it yourself title oxford spell it 276063530939